



Guidance Secondary Board (GSB)

User Manual

Part Number 608742, Revision A



Brooks Automation

Information provided within this document is subject to change without notice, and although believed to be accurate, Brooks Automation assumes no responsibility for any errors, omissions, or inaccuracies.

AcuLigner™, Advan Tag™, AutoTeach™, ATR™, AXM™, BiSymmetrik™, CenterSmart™, Crate to Operate™, CrossingConnect™, DARTS™, Enerta™, e-RMA™, e-Spares™, e-Volution™, Falcon™, FIXLOAD™, FrogLeg™, GuardianPro™, Independent Twin Linear Exchange™, InCooler™, InLigner™, Isoport™, ITLX™, Jet™, Jet Engine™, LEAP™, LeapFrog™, LowProfile™, LPT™, M2 Nano™, Marathon 2, Marathon Express, PASIV™, Pathway™, PowerPak™, PowerTools™, PuroMaxx™, QuadraFly™, Radius™, Radient™, Radient Express™, Reliance™, Reliance ATR™, RetroEase™, SCARA™, SmartPM™, SMIF-INX™, SMIF-LPT™, SPOTLevel™, The New Pathway to Productivity™, Time Optimized Trajectory™, Time Optimal Trajectory™, Time Optimized Path™, TopCooler™, TopLigner™, VacuTran™, VersaPort™, WaferEngine™, LEAP™, Pathway™, GIO, GSB, Guidance 6600, Guidance 6430, Guidance 6420, Guidance 6410, Guidance 6000, Guidance 3400, Guidance 3300, Guidance 3200, Guidance 2600, Guidance 2400, Guidance 2300, Guidance 2200, Guidance 1400, Guidance 1300, Guidance 1200, Guidance 0200 Slave Amplifier, Guidance 0006, Guidance 0004, Guidance Controller, Guidance Development Environment, GDE, Guidance Development Suite, GDS, Guidance Dispense, Guidance Input and Output Module, Guidance Programming Language, GPL, Guidance Slave Board, Guidance System, Guidance System D4/D6, PreciseFlex™ 300, PreciseFlex™ 400, PreciseFlex™ 3400, PreciseFlex™ 1300, PreciseFlex™ 1400, PreciseFlex™ DD4, PreciseFlex™ DD6, PreciseFlex™ DDR, PreciseFlex™ G5400, PreciseFlex™ G5600, PreciseFlex™ G6400, PreciseFlex™ G6410, PreciseFlex™ G6420, PreciseFlex™ G6430, PreciseFlex™ G6600, PreciseFlex™ GSBP Slave Amp, PreciseFlex™ PFD0, PrecisePlace 100, PrecisePlace 0120, PrecisePlace 0130, PrecisePlace 0140, PrecisePlace 1300, PrecisePlace 1400, PrecisePlace 2300, PrecisePlace 2400, PrecisePower 300, PrecisePower 500, PrecisePower 1000, PrecisePower 2000, PreciseVision, and RIO logos are trademarks of Brooks Automation.

Fusion®, Guardian®, MagnaTran®, Marathon®, Razor®, Spartan®, Vision®, Zaris®, and the Brooks and design logo are registered U.S. trademarks of Brooks Automation.

All other trademarks are properties of their respective owners.

© 2024 Brooks Automation. All rights reserved. The information included in this manual is proprietary information of Brooks Automation, and is provided for the use of Brooks customers only and cannot be used for distribution, reproduction, or sale without the express written permission of Brooks Automation.

This technology is subject to United States export Administration Regulations and authorized to the destination only; diversion contrary to U.S. law is prohibited.

<p>Brooks Automation 15 Elizabeth Drive Chelmsford, MA 01824-2400 Tel: +1 978-262-2400 Fax: +1 978-262-2500</p>	<p>Brooks Automation, PreciseFlex Collaborative Robots 201 Lindbergh Avenue Livermore, CA 94551 Tel: +1-408-224-2838</p>
--	---



Worldwide Headquarters

15 Elizabeth Drive
Chelmsford, MA 01824 U.S.A.

Brooks Automation, PreciseFlex Collaborative Robots

201 Lindbergh Avenue
Livermore, CA 94551 U.S.A

Technical Support

Location	Contact	Website
North America	+1-800-447-5007 (Toll-Free) +1-978-262-2900 (Local) +1-408-224-2838 (PreciseFlex™)	
Europe	support_preciseflex@brooksautomation.com	
Japan	+81 120-255-390 (Toll Free) +81 45-330-9005 (Local)	
China	+86 21-5131-7066	http://www.brooks.com/
Taiwan	+886 080-003-5556 (Toll Free) +886 3-5525258 (Local)	
Korea	1800-5116 (Toll Free)	
Singapore	+65 1-800-4-276657 (Toll Free) +65 6309 0701 (Local)	

General Emails

Division	Email Address
Sales	sales_preciseflex@brooksautomation.com
Technical Support	support_preciseflex@brooksautomation.com
Technical Publications	Technical.Publications@brooksautomation.com

Revision History

Revision	ECO	Date	Action	Author
A	EC147051	07/24/2023	Released manual at Rev. A to follow standard Brooks technical publication styles.	M. Ashenfelder

Table of Contents



1. Safety	1
Safety Setup	1
Authorized Personnel Only	1
Explanation of Hazards and Alerts	2
Safety Text	2
Safety Icons	2
Signal Words and Color	2
Alert Example	3
General Safety Considerations	4
Mechanical Hazards	6
Electrical Hazards	7
Ergonomic Hazards	8
Emergency Stop Circuit (E-Stop)	10
Recycling and Hazardous Materials	10
2. Introduction to the Hardware	11
Guidance Slave Board (GSB) Overview	11
System Diagram	12
3. Installation, Configuration, and Software	14
Mounting and Installation	14
GSB Hardware and Software Configuration	15
GSB Unit Number	15
RS-485 Signal Termination	16
Controller Software Configuration	16
24VDC Logic Power Considerations	17
Communication Timing Considerations	17
Recommended Motor and Encoder Wiring	18
Wiring Overview	18
Motor Cables	18
Motor Wiring Path	19
Encoder Considerations	19
Encoder Cables	20
Encoder Wiring and Pin Assignments	20
4. Hardware Reference	22
Connecting Power	22
Controller Connectors	25
Abs Encoder Battery Connector	26
Digital Input and Output Connector	28
Encoder Interfaces	30
External Motor Power Input Connector	32
Motor Interface	33
RS-485 Signal / 24VDC Power Connector	34
RS-485 Termination Jumper	35
Status Red/Green LED	36

Unit Number / Compatibility Jumpers	36
GSB Board Jumpers	38
5. Third Party Equipment	41
Tamagawa Serial Incremental/Absolute Encoder	41
Appendix A: Product Specifications	43

1. Safety

Safety Setup

Brooks uses caution, warning, and danger labels to convey critical information required for the safe and proper operation of the hardware and software. Read and comply with all labels to prevent personal injury and damage to the equipment.

 DANGER Read the Safety Chapter	
<p>Failure to review the <i>Safety</i> chapter and follow the safety warnings can result in serious injury or death.</p> <ul style="list-style-type: none">• All personnel involved with the operation or maintenance of this product must read and understand the information in this safety chapter.• Follow all applicable safety codes of the facility as well as national and international safety codes.• Know the facility safety procedures, safety equipment, and contact information.• Read and understand each procedure before performing it.	

Authorized Personnel Only

This product is intended for use by trained and experienced personnel. Operators must comply with applicable organizational operating procedures, industry standards, and all local, regional, national, and international laws and regulations.

Explanation of Hazards and Alerts

This manual and this product use industry standard hazard alerts to notify the user of personal or equipment safety hazards. Hazard alerts contain safety text, icons, signal words, and colors.

Safety Text

Hazard alert text follows a standard, fixed-order, three-part format.





- Identify the hazard
- State the consequences if the hazard is not avoided
- State how to avoid the hazard.

Safety Icons

- Hazard alerts contain safety icons that graphically identify the hazard.
- The safety icons in this manual conform to ISO 3864 and ANSI Z535 standards.

Signal Words and Color

Signal words inform of the level of hazard.

	<p>Danger indicates a hazardous situation which, if not avoided, will result in serious injury or death.</p> <p>The Danger signal word is white on a red background with an exclamation point inside a yellow triangle with black border.</p>
	<p>Warning indicates a hazardous situation which, if not avoided, could result in serious injury or death.</p> <p>The Warning signal word is black on an orange background with an exclamation point inside a yellow triangle with black border.</p>
	<p>Caution indicates a hazardous situation or unsafe practice which, if not avoided, may result in minor or moderate personal injury.</p> <p>The Caution signal word is black on a yellow background with an exclamation point inside a yellow triangle with black border.</p>
	<p>Notice indicates a situation or unsafe practice which, if not avoided, may result in equipment damage.</p> <p>The Notice signal word is white on blue background with no icon.</p>



Alert Example

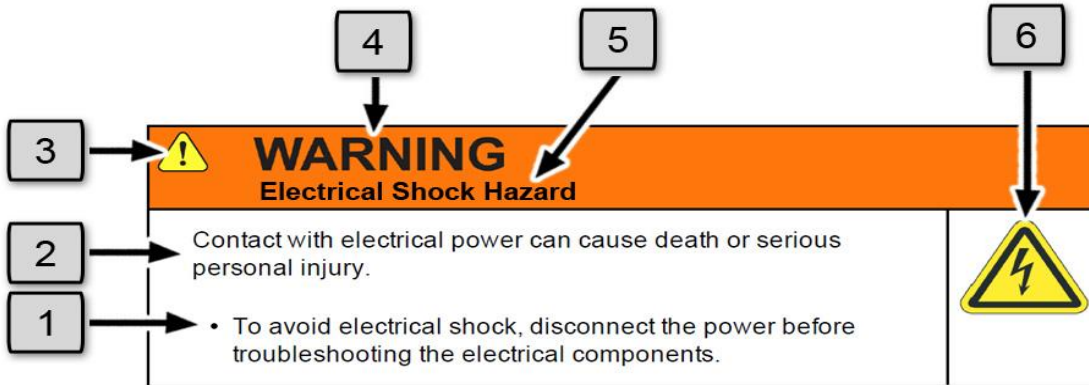

The following is an example of a Warning hazard alert.







Number	Description
1.	How to Avoid the Hazard
2.	Source of Hazard and Severity
3.	General Alert Icon
4.	Signal Word
5.	Type of Hazard
6.	Hazard Symbol(s)



General Safety Considerations



 WARNING Software	
<p>Software is not safety rated. Unplanned motion can occur as long as power is supplied to the motors. Maximum torque could be momentarily applied that may cause equipment damage or personal injury.</p> <ul style="list-style-type: none">• Only operate the robot with its covers installed.• Guarantee that safety controller features are in place (for example, an emergency stop button and protective stop).• Regularly test safety components to prove that they function correctly.	 



 WARNING Robot Mounting	
<p>Before applying power, the robot must be mounted on a rigid test stand, secure surface, or system application. Improperly mounted robots can cause excessive vibration and uncontrolled movement that may cause equipment damage or personal injury.</p> <ul style="list-style-type: none">• Always mount the robot on a secure test stand, surface, or system before applying power.	



 WARNING Do Not Use Unauthorized Parts	
<p>Using parts with different inertial properties with the same robot application can cause the robot's performance to decrease and potentially cause unplanned robot motion that could result in serious personal injury.</p> <ul style="list-style-type: none">• Do not use unauthorized parts.• Confirm that the correct robot application is being used.	

 WARNING Magnetic Field Hazard	
<p>This product contains magnetic motors that can be hazardous to implanted medical devices, such as pacemakers, and cause personal harm, severe injury, or death.</p> <ul style="list-style-type: none">• Maintain a safe working distance of 30 cm from the motor when with an energized robot if you use a cardiac rhythm management device.	



 CAUTION Unauthorized Service	
<p>Personal injury or damage to equipment may result if this product is operated or serviced by untrained or unauthorized personnel.</p> <ul style="list-style-type: none">• Only qualified personnel who have received certified training and have the proper job qualifications are allowed to transport, assemble, operate, or maintain the product.	

 CAUTION Damaged Components	
<p>The use of this product when components or cables appear to be damaged may cause equipment malfunction or personal injury.</p> <ul style="list-style-type: none">• Do not use this product if components or cables appear to be damaged.• Place the product in a location where it will not get damaged.• Route cables and tubing so that they do not become damaged and do not present a personal safety hazard.	



 CAUTION Inappropriate Use	
<p>Use of this product in a manner or for purposes other than for what it is intended may cause equipment damage or personal injury.</p> <ul style="list-style-type: none">• Only use the product for its intended application.• Do not modify this product beyond its original design.• Always operate this product with the covers in place.	

 CAUTION Seismic Restraint	
<p>The use of this product in an earthquake-prone environment may cause equipment damage or personal injury.</p> <ul style="list-style-type: none"> The user is responsible for determining whether the product is used in an earthquake prone environment and installing the appropriate seismic restraints in accordance with local regulations. 	

Mechanical Hazards

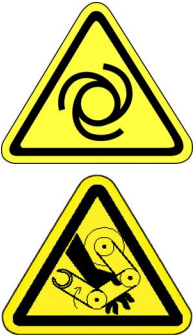

 CAUTION Pinch Point	
<p>Moving parts of the product may cause squeezing or compression of fingers or hands resulting in personal injury.</p> <ul style="list-style-type: none"> Do not operate the product without the protective covers in place. 	



 WARNING Automatic Movement	
<p>Whenever power is applied to the product, there is the potential for automatic or unplanned movement of the product or its components, which could result in personal injury.</p> <ul style="list-style-type: none"> Follow safe practices for working with energized products per the facility requirements. Do not rely on the system software or process technology to prevent unexpected product motion. Do not operate the product without its protective covers in place. While the collaborative robotics system is designed to be safe around personnel, gravity and other factors may present hazards and should be considered. 	



 CAUTION Vibration Hazard	
<p>As with any servo-based device, the robot can enter a vibratory state resulting in mechanical and audible hazards. Vibration indicates a serious problem. Immediately remove power.</p> <ul style="list-style-type: none">• Before energizing, ensure the robot is bolted to a rigid metal chamber or stand.	

Electrical Hazards

Refer to the specifications of the *Guidance Controller Quick Start Guide* for the electrical power.



 DANGER Electrical Shock Hazard	
<p>Contact with electrical power can cause personal harm and serious injury.</p> <ul style="list-style-type: none">• To avoid electrical shock, disconnect the power before troubleshooting the electrical components.• Check the unit's specifications for the actual system power requirements and use appropriate precautions.• Never operate this product without its protection covers on.	



 WARNING Electrical Burn	
<p>Improper electrical connection or connection to an improper electrical supply can result in electrical burns resulting in equipment damage, serious injury, or death.</p> <ul style="list-style-type: none">• Always provide the robot with the proper power supply connectors and ground that are compliant with appropriate electrical codes.	



 WARNING Electrical Fire Hazard	
<p>All energized electrical equipment poses the risk of fire, which may result in severe injury or death. Fires in wiring, fuse boxes, energized electrical equipment, computers, and other electrical sources require a Class C extinguisher.</p> <ul style="list-style-type: none"> Use a fire extinguisher designed for electrical fires (Class C in the US and Class E in Asia). It is the facility's responsibility to determine if any other fire extinguishers are needed for the system that the robot is in. 	

NOTICE
<p>Improper handling of the power source or connecting devices may cause component damage or equipment fire.</p> <ul style="list-style-type: none"> Connect the system to an appropriate electrical supply. Turn off the power before servicing the unit. Turn off the power before disconnecting the cables.

Ergonomic Hazards



 CAUTION Heavy Lift Hazard	
<p>Failure to take the proper precautions before moving the robot could result in back injury and muscle strain.</p> <ul style="list-style-type: none"> Use a lifting device and cart rated for the weight of the drive or arm. Only persons certified in operating the lifting device should be moving the product. 	

 CAUTION Tipover Hazard	
<p>This product has a high center of gravity which may cause the product to tip over and cause serious injury.</p> <ul style="list-style-type: none"> Always properly restrain the product when moving it. Never operate the robot unless it is rigidly mounted. 	

 CAUTION Trip Hazard	
<p>Cables for power and communication and facilities create trip hazards which may cause serious injury.</p> <ul style="list-style-type: none">• Always route the cables where they are not in the way of traffic.	

Emergency Stop Circuit (E-Stop)

The integrator of the robot must provide an emergency stop switch.

 WARNING Emergency Stop Circuit	
<p>Using this product without an emergency stop circuit may cause personal injury.</p> <ul style="list-style-type: none">• Customer is responsible for integrating an emergency stop circuit into their system.• Do not override or bypass the emergency stop circuit.	

Recycling and Hazardous Materials

Brooks Automation complies with the EU Directive 2002/96/EU Waste Electrical and Electronic Equipment (WEEE).

The end user must responsibly dispose of the product and its components when disposal is required. The initial cost of the equipment does not include cost for disposal. For further information and assistance in disposal, please email Brooks Automation Technical Support at support@preciseflex@brooksautomation.com.



2. Introduction to the Hardware

Guidance Slave Board (GSB) Overview

The Guidance Slave Board (GSB) is a very compact single-axis remote servo board that interfaces to any Guidance Controller and enables an additional motor to be controlled. This remote servo can drive a single low voltage motor that is rated up to 100W (or 200W when reduced peak speeds are acceptable). Independent of the Guidance Controller's motor bus voltage, the GSB can support motor bus voltages ranging from 12VDC to 48VDC. GSB modules interface to a controller via a two-wire, bi-directional, daisy chained RS-485 line and can be located up to approximately six (6) meters from the master controller. Depending upon the timing requirements of the application and the available 24VDC power, a mix of as many as eight (8) GSBs or Guidance Input and Output Modules (GIOs) may be connected to a RS-485 cable. (For PreciseFlex™ 400 Sample Handlers with Linear Rails that utilize two internal GSBs, only two (2) additional GSBs or GIOs can be connected due to 24VDC power limitations.)



Figure 2-1: Guidance Slave Board

 WARNING	
<p>The GSB contains unshielded 48VDC signals and pins. This product is intended to be mounted in a cabinet or machine chassis that is not accessible when power is turned on.</p>	

The GSB closes the current and PID loop for the motor that it controls. It relies upon the master controller to generate all trajectory setpoints and higher level motion commands. Once a GSB is interfaced to a Guidance Controller, all of the communication between the remote GSB and the master controller is automatically managed by the system software. From an application configuration and programming perspective, an axis driven by a GSB is accessed in the same manner as any of the local servoed controlled axes (although some advanced features of other Guidance servos have not been implemented on the GSB). For systems that require three (3) or more remote servoed axes or that require high voltage or higher power motors, it is recommended that the user consider utilizing a slave Guidance Controller that interfaces to the master controller via the PreciseFlex Ethernet Servo Network. This alternate solution supports many more remote axes than GSBs and cost-effectively supports a wider range of motors and encoders. For details on the PreciseFlex Ethernet Servo Network and other controllers, refer to the PreciseFlex™ PreciseFlex Library.

System Diagram

Figure 2-2 illustrates how a Guidance Slave Board (GSB) is interfaced to its peripherals and to a master Guidance Controller. One or more GSBs can be slaved to a master controller via a RS-485 communications line. The RS-485 cable provides the logic power for the GSB in addition to the communications.

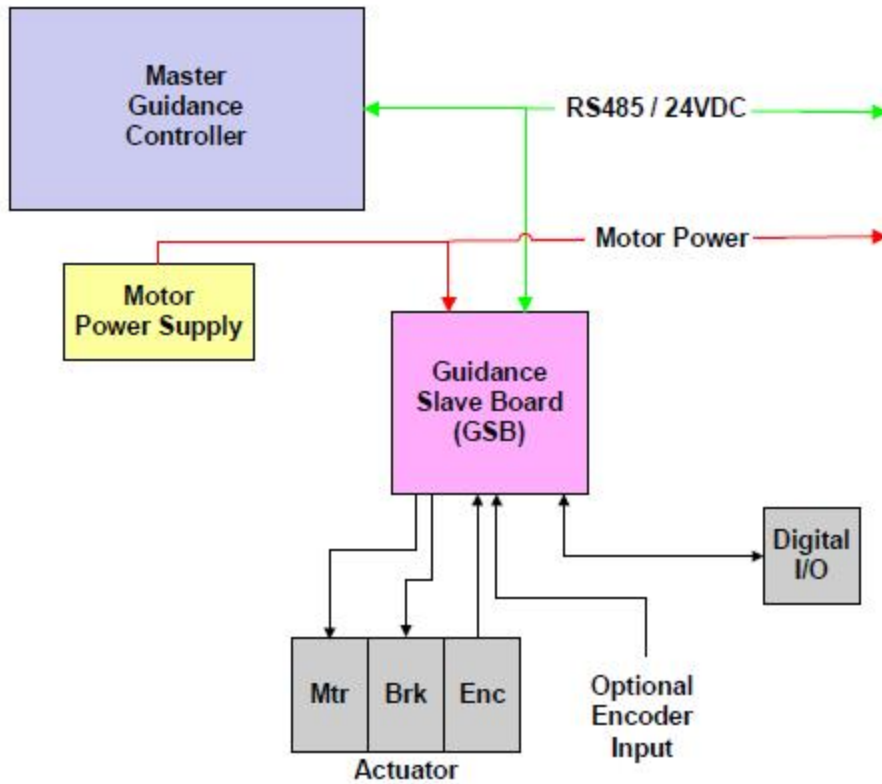

Figure 2-2: System Diagram

Each GSB can control a single servo motor that includes either an incremental encoder or selected absolute encoders. If an absolute encoder is utilized to control the motor, a second optional incremental encoder can also be read. The second encoder can be interfaced to a conveyor belt encoder or other device.

The GSB also includes a limited number of general purpose digital input and output signals, which can be interfaced to over-travel switches or other devices. If these DIO are not used by the GSB servo to control its axis, they may be utilized for general cell control by GPL programs that execute on the master controller.

All of the features of this slave controller are described in detail in the following chapters.

3. Installation, Configuration, and Software

Mounting and Installation

The Guidance Slave Board (GSB) is an open frame device with exposed 48VDC and must be mounted inside of a cabinet or other enclosure. The mounting holes are shown in **Blue** in [Figure 3-1](#) with dimensions in millimeters. There should be sufficient airflow across this board to ensure that the components do not become excessively hot.

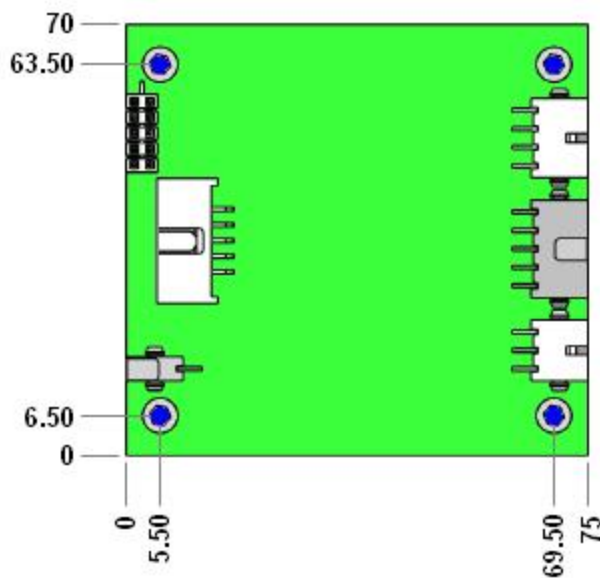



Figure 3-1: The Mounting Holes

 WARNING	
The GSB contains unshielded 48VDC signals and pins. This product is intended to be mounted in a cabinet or machine chassis that is not accessible when power is turned on.	

GSB Hardware and Software Configuration

GSB Unit Number

Up to a maximum of eight (8) GSBs or Guidance Input and Output Modules (GIOs) can be theoretically interfaced to a Guidance Controller. Therefore, this section describes how to configure and address up to eight (8) GSB or GIO boards. However, due to communication timing and 24VDC power considerations, which are described below, a maximum combination of four (4) GSBs or GIOs is a more practical limit except for special system configurations.

GSBs and GIOs can be connected to the RS-485 daisy chain in any order without altering their operation or identification. A GSB or GIO is identified by a unit number that is embedded in its low-level communication messages. Jumpers on the GSB specify this unit number. A GSB's unit number is automatically combined with "GSB_" to generate a keyword that is used to configure the communication protocol between the GSB and its master controller. The unit number can be arbitrary selected and does not need to be sequentially assigned, but each GSB or GIO must have a unique unit number within a given RS-485 system.

The setting of the GSB's [Unit Number Jumpers](#) is presented in [Table 3-1](#) along with the corresponding unit number and keyword identifier.

NOTE: The Unit Number Jumpers for the GSB are J8/J9/J10 whereas the GIO board utilizes J7/J8/J9.

Table 3-1: Unit Number Jumpers & Corresponding Unit Number & Keyword Identifier

J8	J9	J10	GSB Unit	GSB Keyword
In	In	In	1	GSB_1
Out	In	In	2	GSB_2

J8	J9	J10	GSB Unit	GSB Keyword
In	Out	In	3	GSB_3
Out	Out	In	4	GSB_4
In	In	Out	5	GSB_5
Out	In	Out	6	GSB_6
In	Out	Out	7	GSB_7
Out	Out	Out	8	GSB_8

RS-485 Signal Termination

There is one hardware configuration option that is dependent upon the ordering of modules in the RS-485 daisy chain. For noise immunity, termination jumpers must be installed on the GSBs or GIOs or controller on the extreme ends of the RS-485 daisy chain. The termination jumpers must be removed for all controllers or boards in between. On the GSB board, the [Termination Jumper](#) is labeled J6. Consult the hardware description for a specific master controller to determine its RS-485 termination jumper location.

Controller Software Configuration

For the master controller to communicate with a Guidance Slave Board (GSB), the GSB's GSB_Keyword must be entered into the "Servo network node identifier" (DataID 151) parameter database array in the master controller. This provides the controller with the information it requires to communicate with the GSB board. The position of the GSB_Keyword in the DataID 151 array assigns the board a "network node number." Within the controller's software environment, the network node number (and not the GSB's unit number) is used to reference the motor and encoder that is controlled by the GSB. By convention, the first network node is always the master controller and the first element of the DataID 151 is always the controller's serial number.

For example, if the GSB Unit Number Jumpers are set to select unit #4 (Keyword GSB_4), to define the GSB as the second network node, DataID 151 should be defined as follows:

```
DataID 151: "<master>," "GSB_4," "" , "" , "" , "" , "" . . .
```

When a GSB is added to the DataID 151 array, a blank entry cannot precede any non-blank servo node entry. (This rule does not apply to GIO modules.)

24VDC Logic Power Considerations

The GSB must be provided with 24VDC to power both the board's logic and to drive the input and output signals. The amount of 24VDC power available for GSBs may limit the number of boards that can be wired in a system. As a wiring convenience, GSBs and GIOs typically draw the 24VDC power from the same 10-pin daisy chained ribbon cable that provides the RS-485 signals. In this configuration, the Guidance Controller and its associated 24VDC power supply provide the logic and signal power to the GSBs and GIOs. As of 2013, all Guidance Controllers can output a maximum of 2A at 24VDC on the 10-pin RS-485 connector assuming that the controller's 24VDC power supply has sufficient power. Prior to 2013, this was limited to only 1.35A. The minimum power requirement for the GSB's logic is 0.05A. In the worst case, where a board's digital outputs are all driving 100mA, the GSB could draw 0.35. In addition, it is possible for a GSB to derive its motor power for the 24VDC logic power. Even with 2A available from the controller, it might only be possible to support 1 or 2 GSBs. Fortunately, in a typical system, the GSB's digital outputs normally only draw 20mA to 50mA per channel and the motor power is supplied from a different source. The user should expect a typical GSB to draw 0.2A, which permits up to eight 98) GSBs to be interfaced to a single controller.

If GIOs are interfaced, their power consumption must be taken into account as well.

If the controller's available power on the RS-485 cable is not sufficient for an application, an external 24VDC power source can be wired to the GSB and GIO boards (although this is not as convenient).

Communication Timing Considerations

Each GSB exchanges messages with the master controller every motion control trajectory cycle. The trajectory period is determined by the parameter "Trajectory Generator update period in sec" (DataID 600) on the master controller. This parameter typically ranges from 1-4 msec and determines the delay in reading or writing input and output values on the GIO.

As the number of GSB and/or GIO boards increases, the trajectory period must also be increased in order to accommodate the increased transmission times. [Table 3-2](#) shows the maximum number of GSB or GIO nodes possible for different trajectory periods.

Table 3-2: Maximum # of GSB or GIO Nodes Possible for Trajectory Periods

Trajectory period (msec)	Maximum number of GSB or GIO nodes
1	1
2	4
4	8

Recommended Motor and Encoder Wiring

Wiring Overview

To achieve low power losses, the board's motor drive is designed as a switching amplifier with edges that occur as fast as once every 100 nsec. While this aids in keeping the switching losses down, it can make receiving logic level signals from encoders and other sensors more difficult. This is because every PWM edge must charge and discharge the motor wiring capacitance. This can generate current spikes that can cause the motor frame to have ground bounce due to the inductance of the ground return back to the amplifier. This ground bounce and the coupling between motor harness wire and encoder harness wires can introduce noise into the system.

Fortunately, since the Guidance Slave Board (GSB) is limited to relatively low motor voltages, the problem of induced ground bounces is significantly mitigated. However, because other devices in the system may generate similar electrical noise, it is good practice to employ wiring methods that safeguard against such problems.

NOTE: It is very important that the wiring guidelines in this section be followed in order to avoid encoder quadrature errors, zero index errors, and other noise related problems.

Motor Cables

Alpha Wire recommends the following current ratings for wire with PVC insulation at 80C. In general, the wire ratings should meet or exceed the RMS (rated) current of the motor and not the peak current since the primary concern is over-heating the wire due to excessive average motor currents.

Table 3-3: Current Ratings for Wire with PVC Insulation at 80C

Wire Size AWG	28	26	24	22	20	18
Amperes	3	4	6	8	10	15

If even higher current ratings are required, Teflon or other high temperature insulation permits higher currents for a given wire size. For example, 22 AWG wire with Teflon insulation has a current rating of 13A at 200C.

As an extra precaution, it is recommend that the motor wire should be shielded and have a rating of 150 volts or more. The typical wires that are shown in the table below have a 105°C rating. These wires do not have a drain wire, so a drain connection must be soldered to the shield.

Table 3-4: Wires with a 105°C Rating

	Alpha 18 AWG	SAB 22 AWG
High Flex	85803CY	7840503 5 conductor shielded cable
Moderate Flex	65803CY	
No Flex	3242	

Motor Wiring Path

Since the ground bounce of motors connected to this board will be small due to their low voltages, the motor cables for this controller do not require ferrite beads. (“Ferrite beads” are sometimes referred to as “ferrite chokes” or “ferrite cores”.)

NOTE: If also wiring a Guidance 2000 or 3000 controller with high voltage motors, consult the wiring instruction for those controllers because their recommended wiring practices are significantly different.

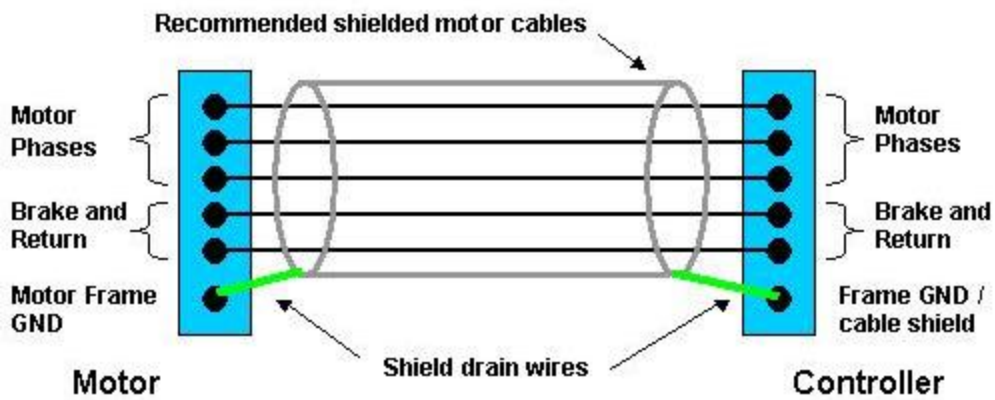

Figure 3-2: Recommended Motor Wiring

Figure 3-2 illustrates how the motor cable should be wired. The shield around the motor cable is optional, but a good practice to follow.

Encoder Considerations

The preferred encoder should have a differential cable driver built in. The differential signal will cancel out much of the common mode noise that encoder wiring can pick up and, when used with twisted pair wire, will cancel out the magnetic pick up from the motor harness.

Some encoders have an open collector output or an output with only a 10K pull up resistor. These encoders should only be used with a cable driver IC such as a DS26C31 mounted nearby the

encoder or the encoder should be mounted within five (5) feet of controller and wired with shielded cable.

If an encoder's code wheel or linear mask is made with etched metal or other conductive material, the encoder should not be used if it is mounted to any housing or chassis that has ground bounce on it. For example, if such an encoder is directly mounted to a motor frame without electric insulation, its use could result in quadrature errors and other noise problems.

Encoder Cables

It is recommended that the encoder cable be shielded and contain 4 twisted pairs with a gauge of AWG 24 or AWG 26. See [Table 3-5](#) for recommended cables.

NOTE: Unshielded non-twisted pair encoder wiring should never be run next to unshielded motor wiring or other possible noise sources.

Table 3-5: Encoder Cables

	Alpha 24 AWG	Alpha 26 AWG	Beldon 24 AWG	SAB 26 AWG
High Flex	86604CY	86504CY		07890414
No Flex	5494C 5272C		88104	

One of the twisted pairs should be used for power and ground, one pair for A+ and A-, one pair for B+ and B- and one pair for Z+ and Z- (see the next section.). Connect the shield to one of the ground pins on the controller encoder connector. For encoders that are in a metal box with a metal shell connector, on the encoder end of the cable, connect the shield to the metal shell of the mating connector.

Encoder Wiring and Pin Assignments

The encoder connector on the Guidance Slave Board (GSB) provides pins for interfacing to a differential incremental encoder or an absolute encoder. This interface can also be utilized to connect to single-ended encoders. However, it is always best to select an encoder with differential signals for the greatest noise immunity. Refer to the section on [Third Party Equipment](#) for specific pin assignment for absolute encoders.

If a single-end encoder is connected using twisted pair wire, the low side of both ends of each twisted pair should be connected to ground, and the A-, B-, and Z- signals of the controller's

differential encoder inputs should each be pulled to 5V through a 2K resistor. The A+, B+ and Z+ signals should be connected without any special modifications. For high volume OEM applications, surface mounted pull-up resistors can be installed at Brooks' factory to configure specific encoder channels for single-ended encoders. For qualified applications, contact PreciseFlex Sales to discuss this option.

Due to pin limitations, if several wires must be connected to a single pin, a larger crimp pin should be used.

Figure 3-3 illustrates how to interface to a differential encoder.

NOTE: Especially for high frequency signals, such as those required for serial absolute encoders, it is critical that shielded twisted pair cable be used all the way from the encoder to the controller. Even a 300mm unshielded non-twisted pair cable from the controller to a bulkhead connector can result in significant signal corruption.

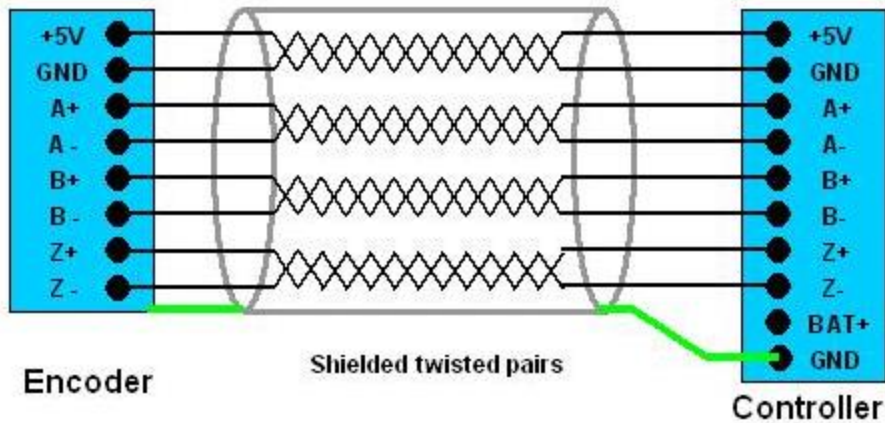

Figure 3-3: Differential Encoder Wiring and Pin Assignments

4. Hardware Reference

Connecting Power

The Guidance Slave Board (GSB) must be provided with power for its logic and power to drive the motor. The typical method for wiring the power sources to this board is illustrated in [Figure 4-1](#). In this drawing, optional connections are indicated by dotted lines.

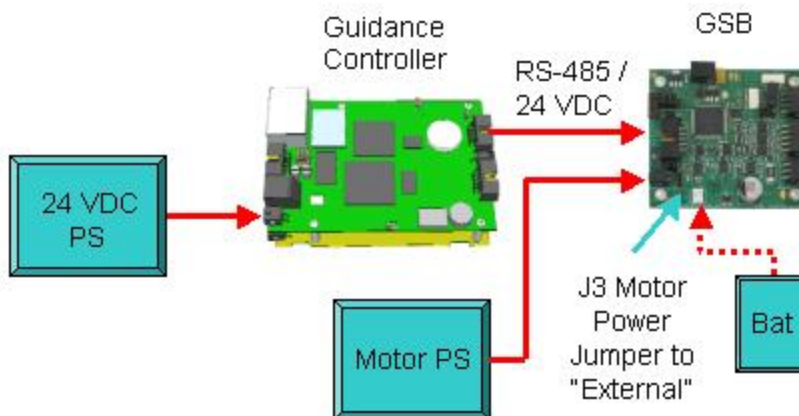



Figure 4-1: Standard Power Wiring

 WARNING	
The GSB contains unshielded 48VDC signals and pins. This product is intended to be mounted in a cabinet or machine chassis that is not accessible when power is turned on.	



The GSBs logic is powered by a 24VDC source, which, as a wiring convenience, is typically supplied by the master Guidance Controller via the [RS-485 / 24 VDC](#) cable. (The one exception to this

rule is when [multiple GSBs and GIOs](#) are drawing too much power from this cable, the 24VDC can be wired separately.)

In standard installations, the motor power is provided by a separate power supply that is connected to the GSB's [External Motor Power Input Connector](#). This separate connection permits the motor voltage to range from 12VDC to 48VDC and allows higher currents than is available from the RS-485/ 24VDC cable.

NOTE: Even if the motor power supply is 24VDC, keep the motor power supply separate from the 24VDC logic power supply.

When motors decelerate, they can regenerate significant power that flows back to the motor power supply. If the motor power supply is not designed to absorb this regenerated energy, the voltage of the motor supply can rise significantly. If this power supply is also connected to the controller's digital logic, the pumped up voltage can damage the controllers in the system or can cause the 24VDC power supply to shutdown due to an over-voltage error.

 WARNING	
If the voltage supplied to a controller's digital logic exceeds 30VDC, the controller's hardware will be damaged. Motor power supply voltage pump-up from decelerating motors can significantly exceed this limit so the motor supply should not be connected to the controller's logic unless the supply is specifically designed to absorb this energy and limit the voltage rise.	

Even when separate logic and motor power supplies are utilized, regenerated energy flowing back to the motor power supply may still cause problems. Unless the motor power supply is designed to absorb this energy, a significant voltage rise in the motor power supply may shut down this power supply or the GSB may disable power to its motor to prevent the motor power amplifier from being damaged. If a significant voltage rise is possible, an external Power Regeneration (Dump) circuit should be added to the motor power supply.

Both the 24VDC logic power and the motor power should be continuously enabled when the GSB is operational. The GSB automatically internally manages connecting and disconnecting the motor voltage from its power amplifier whenever motor power is enabled or disabled.

When motor power is connected to the External Motor Power Connector, the [J3 Motor Power Jumper](#) must be left in its default setting of "External."

In addition to the logic and motor power supplies, when certain types of absolute encoders are utilized, battery power must be supplied to the encoders when the controller is powered down in order for the encoders to retain their multiple turn counters. In this case, an external battery should

be connected to the [Abs Encoder Battery Connector](#). Refer to the [Third Party Equipment](#) section for more information on absolute encoders and their battery requirements.

As a special case, if a 24VDC motor is being utilized and it draws very little current and regenerates very little power when it decelerates, the motor power can be taken from the 24VDC supplied by the RS-485 / 24VDC connector.

WARNING

The GSB contains unshielded 48VDC signals and pins. This product is intended to be mounted in a cabinet or machine chassis that is not accessible when power is turned on.



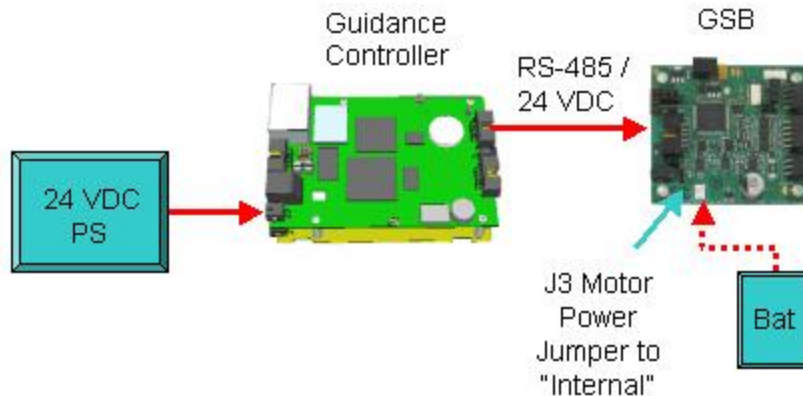



Figure 4-2: 24VDC Low-Power Motor Wiring

In this case, the [J3 Motor Power Jumper](#) must be set to "Internal."

The obvious advantage of this method is that a single power supply can be utilized and the cable to interface the motor power supply to the GSB is not needed. However, this method must be used with caution: the maximum available current supplied by the RS-485 / 24VDC connector and the Guidance Controller must not be exceeded; the motor must operate at 24VDC; and the motor must not regenerate excessive current when it decelerates such that the 24VDC voltage excessively rises and damages both the GSBs and Guidance Controller's digital logic.

 WARNING	
<p>If the voltage supplied to a controller's digital logic exceeds 26.4VDC, the controller's hardware will be damaged. Motor power supply voltage pump-up from decelerating motors can significantly exceed this limit so the motor supply should not be connected to the controller's logic unless the supply is specifically designed to absorb this energy and limit the voltage rise.</p>	

Controller Connectors

In addition to the motor and encoder interfaces, the GSB includes a limited number of other IO for interfacing to limit switches and other devices. Detailed information for all of the GSB's interfaces and the board's configuration hardware is provided in this section. This includes information on the following:

- [Absolute Encoder Battery Connector](#)
- [Digital Input / Output Connector](#)
- [Encoder Interfaces](#)
- [External Motor Power Input Connector](#)
- [External / Internal Motor Power Jumper](#)
- [Motor Interface](#)
- [RS-485 Signal / 24 VDC Power Connector](#)
- [RS-485 Termination Jumper](#)
- [Status Red/Green LED](#)
- [Unit Number / Compatibility Jumpers](#)
- [GSB Board Jumpers](#)

Figure 4-3 illustrates the top surface of the GSB and identifies each of the user's connectors and the major configuration components. To jump to the detailed information for a specific connector, click on the connector interface name or the connector.

 **WARNING**

The GSB contains unshielded 48 VDC signals and pins. This product is intended to be mounted in a cabinet or machine chassis that is not accessible when power is turned on.

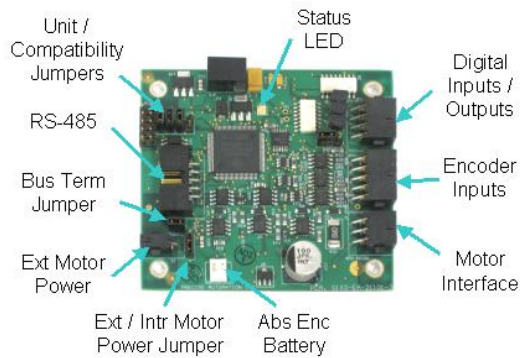



Figure 4-3: The Top Surface of the GSB

In the following sections, the pin outs for each of the connectors and the settings for the jumpers are described.

Abs Encoder Battery Connector

Many commercially available absolute encoders require a modest amount of battery power in order to retain their multiple turn counters when the controller is powered down. If the motor that is connected to the GSB is equipped with this type of encoder, a suitable battery source must be connected to the GSB's encoder battery connector.

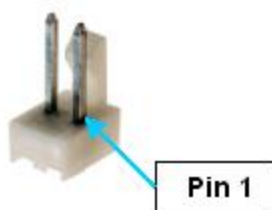

Figure 4-4: Molex 22-11-2022

From the Abs Encoder Battery Connector, the battery power flows to pins in the encoder connector. Refer to the reference pages for the [Encoder Interfaces](#) for additional information. Refer to the specific information for the encoder for the recommended battery voltage and capacity.

NOTE: Due to the low voltage of batteries and the very low current drain of encoders in standby mode, a poor or higher resistance connection between the battery and the encoder can result in a momentary loss of power to the encoder. Even a very short loss of power can result in an absolute encoder losing its calibration data and signaling a low battery voltage error. So, all connectors from the battery, through the controller and out to the encoder must be gold plated with high compression forces and all wires must have very low resistance.

For several types of absolute encoders, a 3.6V lithium ion backup battery, such as a Tadiran TL-5903, can be used to power the multi-turn counters when the controller's power is turned off. This is a AA battery that should last for ten years for one encoder load.

Table 4-1: Pin Descriptions

Pin	Description
1	+VBAT
2	GND
User Plug Part for Molex 22-11-2022	Housing: TE 1375820-2, Sockets: TE 1375819-2

Digital Input and Output Connector

The GSB provides three (3) general purpose optically isolated digital input signals and three (3) general purpose optically isolated digital output signals. These IO can be utilized as remote DIO by the master Guidance Controller for general workcell interfacing; driving an LED, encoder latching inputs for conveyor tracking or camera synchronization; inputs to the GSB servo for homing or limit stops; etc. These signals are presented in an 8-pin AMP 3-794618-8 that mates with an AMP 794617-8 plug. This type of connector permits these signals to be easily interfaced to other devices.

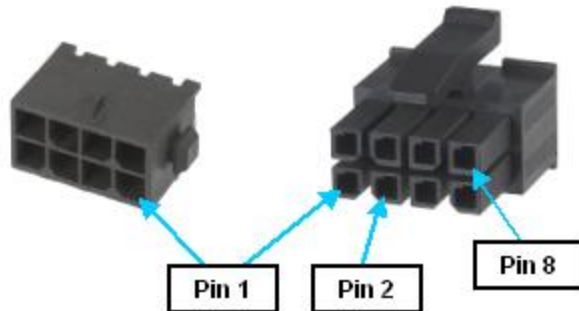

Figure 4-5: AMP 3-794618-8 and AMP 794617-8 Connectors

The three (3) digital input signals are configured as "sinking." That is, the external equipment must provide a 5 VDC to 24 VDC voltage to indicate a logical high value or must allow it to float to no voltage for a logical low. For convenience, the 8-pin connector supplies 24VDC. These inputs are compatible with "sourcing" (PNP) sensors.

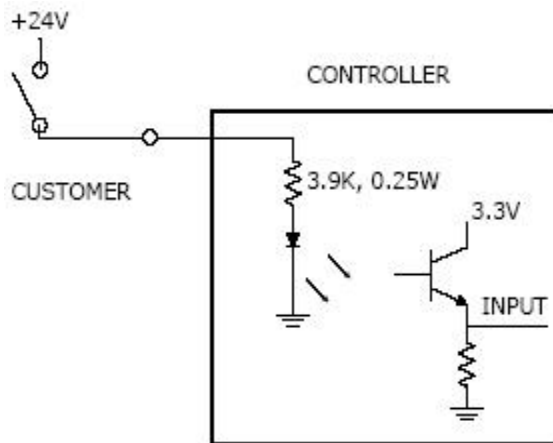

Figure 4-6: DIO Sinking Input

The (3) three digital output signals are configured as "sourcing." That is, the external equipment must pull-down an output pin to ground, and the GSB pulls this pin to 24VDC when the signal is asserted as true. Each output signal can supply a maximum of 100 mA. For convenience, a ground pin is supplied in the 8-pin connector. These outputs are compatible with "sinking" (NPN) devices.

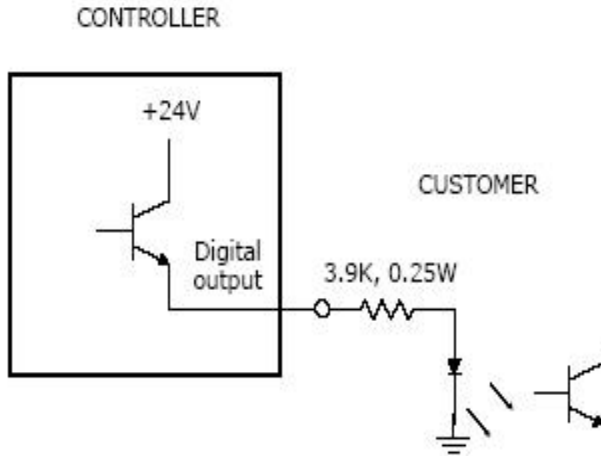

Figure 4-7: DIO Sourcing Output

As a convenience for driving a LED, the GSB includes a built-in 1K resistor that is in series with the output of the 3rd DOUT signal. This permits a typical 3V 20mA LED to be driven directly with no additional components.

NOTE: The internal 1K resistor on digital output 3, which was designed to simplify interfacing to a LED, limits the amount of voltage and current that this signal can externally drive.

To support future capability required by the PreciseFlex™ 400 robot, the connector pins for digital input #1 and digital output #3 can be [jumpered](#) to connect their signals directly to two pins, RXD and TXD, on the [RS-485 connector](#). When these pins are jumpered, the corresponding digital input and output signals are unconnected. For most configurations, these jumpers should be left in their default positions to permit all 6 DIO signals to operate properly.

The pin out for the Digital Input and Output Connector and the corresponding GPL signal numbers are described in the following table. For the GPL signal numbers "n" is the GSB's Network Node number that is defined when configuring the master controller, not the GSB's unit number.

Table 4-2: Pin Out and Corresponding GPL Signal Numbers

Pin	GPL Signal Number	Description
1	n00013	Digital Output 1
2	n00014	Digital Output 2
3	n00015	Digital Output 3. This signal is intended to drive a low voltage/low current LED. It has a 1K resistor in series with this signal, which limits the output to 3V and 20mA for a typical LED. This pin can be optionally jumpered to connect to the TXD pin in the RS-485 connector .

Pin	GPL Signal Number	Description
4		24 VDC output
5		GND
6	n10001	Digital Input 1. This pin can be optionally jumpered to connect to the RXD pin in the RS-485 connector .
7	n10002	Digital Input 2
8	n10003	Digital Input 3
User Plug Part No		AMP 794617-8. Use an AMP 91501-1 hand tool and AMP 794610-1 sockets for wiring to the plug.

Encoder Interfaces

The GSB includes an encoder connector that supports an interface to one digital incremental quadrature encoder or one serial absolute encoder or one serial absolute encoder plus a digital incremental quadrature encoder with no index signal. The signals for the encoder interfaces are provided in a ten-pin Amp 4-794620-0 connector that mates with an Amp 1-794617-0 plug.

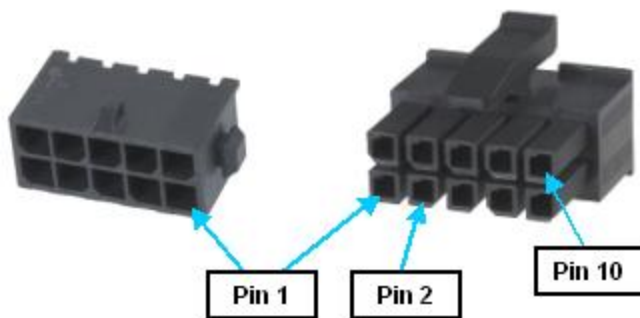

Figure 4-8: Ten-pin Amp 4-794620-0 Connector and Amp 1-794617-0 Plug

The encoder interface can be configured for a differential or single-ended incremental encoder or a variety of absolute encoders (the differential/single-ended hardware configuration must be set at the factory). Since many absolute encoders require external battery backup power to retain the memory of their revolutions counters, the encoder interface includes a battery power line that is directly connected to the [Abs Encoder Battery Connector](#). Refer to the [Third Party Equipment](#) section of this manual for more information on configuring and wiring absolute encoders.

If the GSB is a revision 2 board (GSB2) or a revision 3 board (GSB3) that is [jumpered to operate in compatibility mode](#), quadrature incremental encoders only produce 2 encoder counts for each A-B

signal sequence. If a GSB3 is jumpered to operate in its native mode, 4 encoder counts are regenerated for each A-B signal sequence. For example, if an encoder has 1000 lines, a GSB2 or GSB3 in compatibility mode will receive 2000 counts per encoder rotation and a GSB3 in native mode will receive 4000 encoder counts.

NOTE: It is strongly advised that the user review the [Installation section](#) of this manual for recommendations on best practices for wiring encoders. Following the provided instructions will significantly reduce the likelihood of any problems due to noise in the encoder signals.

The pin out for each Encoder Connector is described in [Table 4-3](#).

Table 4-3: Encoder Connector Pin Outs

Pin	Description
1	GND
2	Encoder Z+
3	Encoder B-
4	Absolute encoder battery+ output
5	Encoder A+
6	Encoder Z-
7	GND / Absolute encoder battery-
8	Encoder B+
9	Encoder A-
10	5 VDC output provided to power encoders. The current drawn is limited to 250 mA.
User Plug Part No	Amp 1-794617-0. Use an AMP 91501-1 hand tool and AMP 1-794610-2 sockets for wiring to the plug.

External Motor Power Input Connector

The power to drive the motor is normally supplied separately from the logic power. The 24VDC logic power is provided on the [RS-485 / 24 VDC](#) connector. In the special case where a low power 24VDC motor is interfaced, the motor power can be derived from the logic power.

However, in most systems, the motor power is provided via the External Motor Power Input connector. This input permits higher power to be supplied to the motor with voltages ranging from 12VDC to 48VDC. The power is provided via a two-pin AMP 3-794620-2 connector. The mating plug is an AMP 794617-2.

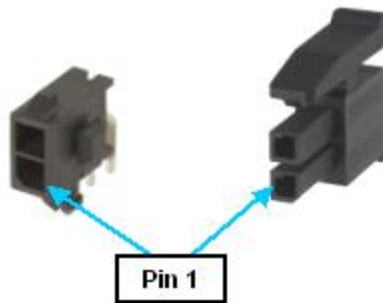

Figure 4-9: AMP 3-794620-2 Connector and AMP 794617-2 Mating Plug

As with the 24VDC logic power, the motor power provided on this connector should be supplied continuously, independent of whether the motor is enabled or disabled. The GSB automatically manages switching on and off the power to the motor power amplifiers as required.

To configure if the motor power is derived from this connector or the 24VDC logic power, an [Ext / Intr Motor Power Jumper](#) is provided. By default, this jumper is set to draw the motor power from this connector.

The pin out for the External Motor Power Connector is described in [Table 4-4](#).

Table 4-4: Pin Out for the External Motor Power Connector

Pin	Description
1	Motor power input, 24VDC to 48VDC.
2	GND
User Plug Part No	AMP 794617-2. Use an AMP 91501-1 hand tool and AMP 794610-1 sockets for wiring to the plug.

Motor Interface

The GSB is equipped with a single motor drive. The motor drive interface is provided in a 6-pin AMP 3-794618-6 connector that mates with an AMP 794617-6 plug.

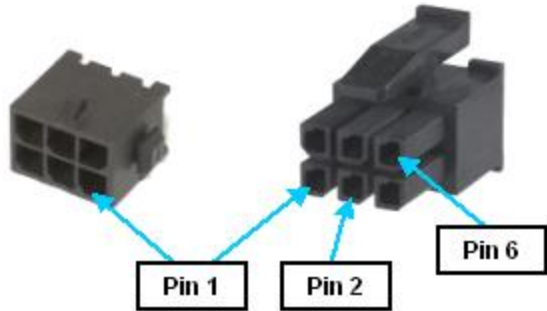

Figure 4-10: AMP 3-794618-6 Connector and AMP 794617-6 Plug

As a wiring convenience, the motor connector includes a brake control signal for energizing (releasing) a brake.

Review the [Installation section](#) of this manual for recommendations on best practices for wiring motors. Following the provided instructions will significantly reduce the likelihood of the motors generating undesirable electrical noise.

The pin out for the Motor Connector is described in [Table 4-5](#).

Table 4-5: Pin Out for the Motor Connector

Pin	Description
1	Brake power output, 24VDC, maximum current 1A total for the brake
2	Motor phase V
3	Motor phase W
4	Brake power return. Set to ground to energize (release) brakes otherwise 24VDC.
5	Motor frame ground/cable shield
6	Motor phase U
User Plug Part No	AMP 794617-6. Use an AMP 91501-1 hand tool and AMP 794610-1 sockets for wiring to the plug.

RS-485 Signal / 24VDC Power Connector

The GSB communicates with a Guidance Controller using a RS-485 interface. RS-485 is a two-wire, bi-directional, multi-drop, daisy chained, high-speed serial interface. Once the GSB and controller are connected and configured, the controller's operating system automatically manages communicating motion control messages with the GSB at a regular interval without requiring special user programming.

The RS-485 signals are provided in an IDC connector. To simplify wiring, this connector also provides the 24VDC logic power and ground lines that are necessary to operate the GSB. If a single GSB module is interfaced to a Guidance Controller, a simple ribbon cable with an IDC connector on each end can connect the GSB to the controller and provide both communication signals and logic power to the GSB.

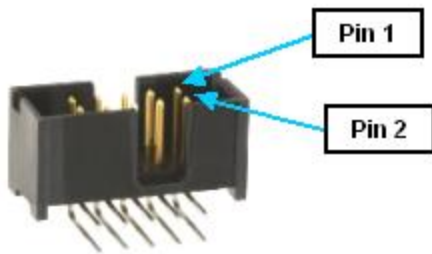

Figure 4-11: IDC 5103310-1 Connector

For reliable communications, [termination jumpers](#) must be installed on the GSBs, GIOs or controllers on the extreme ends of the RS-485 daisy chain. The termination jumpers must be removed for all controllers or boards in between.

To support future capability required by the PreciseFlex™ robot, two of the pins on this connector, TXD and RXD, can be [jumped](#) to pass through signals from the [Digital Input and Output Connector](#).

The pin out for the RS-485/24VDC Power Connector is described in [Table 4-6](#).

Table 4-6: Pin Out for the RS-485/24VDC Power Connector

Pin	Description
1	24VDC. A minimum of 0.05 Amps is required for the GSB's logic power. A maximum of 0.3 Amps additional is required when all 3 digital outputs are driving 100mA each. If the digital outputs are driving less than 100ma each, the additional 0.3 Amps will be reduced accordingly. In a typical system, sourcing outputs normally drive 20mA to 50mA. If the board is configured to drive the motor from the 24VDC logic power provided by this connector or if the motor has a brake, the additional power must be factored into the current requirements.
2	
3	RXD. This can be optionally jumped to pass through the signal that is normally directed to Digital Input #1 . If not jumped, this pin is unconnected.

Pin	Description
4	TXD. This can be optionally jumpered to pass through the pin that is normally driven by Digital Output #3 . If not jumpered, this pin is unconnected.
5	GND
6	Not connected
7	GND
8	RS485+
9	RS485-
10	GND
User Plug Part No	AMP 746285-1 or Molex 22-55-2101 or 90142-0010. For the Molex plug, use Molex sockets 16-02-0103 and Molex crimp tool 63811-1000.

RS-485 Termination Jumper

For the RS-485 daisy chained serial bus to operate properly, the ends of the bus must be electrically terminated. This electrical termination prevents transmitted signals from being reflected back into the cable and corrupting valid data. However, interior boards in the daisy chain must not have any electrical termination.

To allow a GSB to be placed anywhere in a RS-485 daisy chain, this board includes configurable bus termination that is controlled by [two jumper posts at position J6](#) on the top surface of the board.



Figure 4-12: Jumper Posts

When a GSB is placed at either end of a RS-485 daisy chain, the two (2) posts must be jumpered together to terminate the bus. When a GSB is placed at an interior node of a chain, the jumper must be removed. As shipped from the factory, the jumper is installed and the GSB is ready to be connected at either end of a chain.

Status Red/Green LED

The GSB module includes a Status LED mounted on its top surface. This indicates the power and execution state of the board. The interpretation of this red and green LED is described in [Table 4-7](#).

Table 4-7: Interpretation of Red and Green LED

LED State	System Status	Description
Continuously off or on	(1) Logic power off or (2) CPU crashed	Normally indicates that 24VDC logic power is off. In rare instances, indicates that the GSB CPU has crashed due to a system hardware or software error.
Alternating red and green	Board booting	The 24VDC logic power has been turned on and the GSB board is being initialized. If this state continues for more than a minute or two, it usually indicates a hardware failure.
Blinking red single	Board operating, waiting for communications.	The GSB CPU has completed its startup process and is operational. The GSB is waiting for RS-485 communication with the master Guidance Controller to be established.
Blinking red double	Board idle, not communicating	The GSB did not connect to the master controller within 1 minute of boot and is no longer listening to the RS-485. It will not connect until it has been rebooted.
Blinking green	Normal operation, drive ready or active	The GSB is operational and is actively communicating with the master Guidance Controller. The board is able to servo control an attached motor.

Unit Number / Compatibility Jumpers

In the low-level RS-485 communications, the "unit number" determines which GSB is the originator or recipient of each message, not the position of the GSB board in the RS-485 daisy chain. This unit number is configurable using a group of three jumper posts on the top of the GSB board. The unit numbers can be arbitrarily assigned and do not have to be sequential, but they do have to be unique within a controller system.



Figure 4-13: Jumper Posts

The unit number also determines a keyword ("GSB_<unit_number>") that is specified to configure a GSB board as a node in a controller's Servo Network.

NOTE: At the software application level, the network node number and not the GSB board unit number determines how the GSB's motor and encoder are addressed.

In addition, this block of jumper posts include [a pair of posts \(J11\)](#) that determine if the GSB operates in "native" mode (jumper installed) or "compatibility" mode (jumper removed). If a version 3 GSB (GSB3) is configured for compatibility mode, it can be used interchangeably with a version 2 GSB (GSB2) and will perform the same as a GSB2 given the same set of controller configuration (*.PAC) files. This mode setting is particularly important if a [digital incremental encoder](#) is interfaced to the GSB since it alters the effective resolution of the encoder and the current loop tuning. In general, when setting up a new robot model for the first time, "native" mode should be selected.

For more information on node numbers and configuring the controller, refer to the [Hardware and Software Configuration](#) section of this manual.

In [Table 4-8](#), the interpretation of the [Unit Number Jumpers \(J8, J9, J10\)](#) is provided. As shipped from the factory, all of the jumpers are installed, which indicates GSB unit #1.

NOTE: The Unit Number Jumpers for the GSB are J8/J9/J10 whereas the GIO board utilizes J7/J8/J9.

Table 4-8: Interpretation of Unit Number Jumpers (J8, J9, J10)

J8	J9	J10	GSB Unit	GSB Keyword
In	In	In	1	GSB_1
Out	In	In	2	GSB_2
In	Out	In	3	GSB_3
Out	Out	In	4	GSB_4
In	In	Out	5	GSB_5
Out	In	Out	6	GSB_6
In	Out	Out	7	GSB_7
Out	Out	Out	8	GSB_8

GSB Board Jumpers

The GSB has a number of hardware jumpers that determine the configuration of various hardware functions. Depending upon the type of jumper, there may be two or three jumper posts. Posts are tied (shorted) together using black jumper plugs. The three wide jumper for configuring the motor drive voltage is shown below.



Figure 4-14: Three-wide Jumper for Configuring the Motor Drive Voltage

The locations of each of the key sets of jumpers are illustrated in [Figure 4-15](#) and are identified by stenciled labels on the surface of the GSB board.

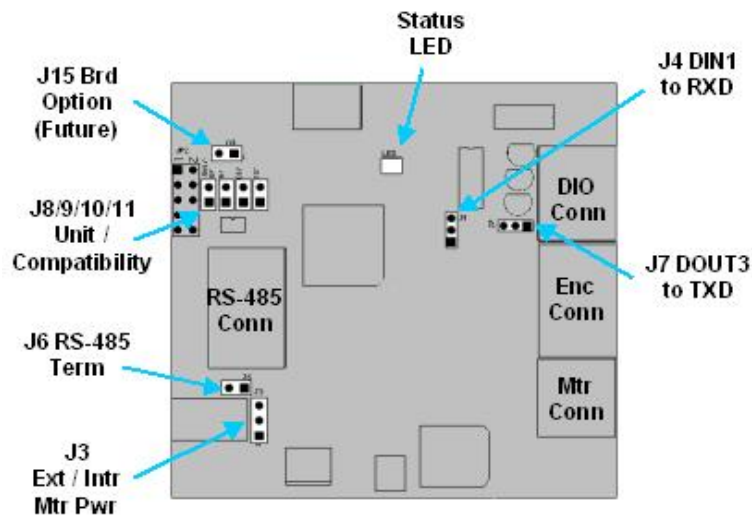

Figure 4-15: Key Sets of Jumpers

[Table 4-9](#) describes each of the sets of jumpers and how the pins must be shorted ("jumped") in order to set a specific configuration. When a direction (e.g. left versus right) is described, it is with respect to the GSB board oriented as shown in [Figure 4-15](#).

Table 4-9: Jumper Instructions

Jumpers	Description	Setting
J15 Brd Option (Future)	This jumper is currently unused but will be used in the future to indicate the presence of a hardware/software option. As shipped from the factory, this jumper is not installed.	Always removed.
J8/J9/J10/J11 Unit Number / Compatibility	The right-most jumper in this group (J11) determines if a GSB3 board operates compatibly with a GSB2 and can execute properly with the same set of controller configuration (*.PAC) files. If this jumper is not installed in a GSB3, the GSB3 operates in compatibility mode. When a new robot is being configured for the first time, native (non-compatibility) mode should generally be selected since this makes use of all of the features of the GSB3. The setting of the compatibility mode jumper is especially important when an incremental quadrature encoder is utilized. As shipped from the factory, this jumper is installed.	Remove right-most jumper (J11) in GSB3 to execute compatibly with GSB2. Install for native mode.
	In the low-level RS-485 communication protocol, the Unit Number (J8/J9/J10) determines which GSB is the originator or recipient of each message, not the position of the GSB board in the RS-485 daisy chain. See the Unit Number /Compatibility Jumpers section for a description of these jumpers. The left most jumper is J8. As shipped from the factory, all three (3) of these jumpers are installed and the board is set to unit #1.	Install or remove left 3 jumpers to define GSB Unit Number.
J7 DOUT3 to TXD	This jumper is provided to support a future capability of the PreciseFlex 400 robot. It determines whether pin 3 of the GSB Digital Input and Output Signal connector conveys the 3 rd local digital output signal DOUT3 (standard configuration) or whether this pin is connected to the TXD pin of the RS-485 connector . NOTE: <i>In the standard configuration, DOUT3 has a 1k resistor in series with its output. This limits the current and voltage that can be output by this signal and was designed to permit a LED to be directly driven by DOUT3. As shipped from the factory, this jumper selects DOUT3 to output.</i>	Always jumper J7-2 to J7-3 (left most pins) to enable DOUT3 Jumper J7-1 to J7-2 (right most pins) to connect the DOUT3 pin to the TXD pin
J6 RS-485 Bus Termination	This jumper controls if RS-485 Bus Termination is enabled on this board. For reliable communications, if a GSB is at the end of a RS-485 daisy chain, this jumper must be installed to terminate the communication line. If a GSB is in the middle of a RS-485 daisy chain, this jumper must be uninstalled to disable the termination. As shipped from the factory, this jumper is installed and the GSB should be installed at the end of the RS-485 daisy chain.	Install jumper J6 to terminate the RS-485 communication lines.
J4 DIN1 to RXD	This jumper is provided to support a future capability of the PreciseFlex 400 robot. It determines whether pin 6 of the GSB Digital Input and Output Signal connector is connected to the first local digital input signal DIN1 (standard configuration) or whether this pin is connected to the RXD pin of the RS-485 connector . As shipped from the factory, this jumper selects DIN1 input.	Always jumper J4-2 to J4-3 (top most pins) to enable DIN1 Jumper J4-1 to J4-2 (bottom pins) to connect the DIN1 pin to the RXD pin

Jumpers	Description	Setting
J3 Ext / Intr Mtr Pwr	This jumper controls whether the power to drive the motor comes from the External Motor Power Input Connector or whether power is derived from the internal 24VDC logic power that is provided by the RS-485 Signal / 24 VDC Power Connector . Most systems require that an external power source be provided, which permits higher powered motors to be driven and voltages up to 48VDC. However, for systems that utilize a low power motor, it may be acceptable to siphon some of the 24VDC that normally powers the logic of the GSB board. This eliminates the need to provide a separate power supply and power cable. As shipped from the factory, this jumper is set to select external motor power.	For external motor power (standard), jumper J3-2 to J3-3 (top most posts) For nternal power, jumper J3-1 to J3-2 (lower most posts)
Status LED	This is a green and red LED that blinks to indicate the operational status of the controller.	

5. Third Party Equipment

This section contains instructions on interfacing to 3rd party equipment that is commonly utilized in combination with the Guidance Slave Board (GSB). For detailed information on each of these products, please refer to the manuals provided by the manufactures of these components.

Tamagawa Serial Incremental/Absolute Encoder

This section provides wiring instructions for a motor equipped with a Tamagawa SA35-17/33Bit-LPS (TS5667N120/N127) absolute encoder. This encoder transmits its position data as a serial bit stream via RS-485 lines rather than A-B incremental pulses. This encoder can be utilized as high resolution incremental encoder that provides 17-bits of resolution per revolution. In addition, if this encoder is provided with continuous power with a battery backup, it functions as a high resolution absolute encoder that provides 33-bits of encoder position information. The continuous power maintains a 16-bit "turns count" register that augments the 17-bits per turn data.

For information on configuring this type of encoder, refer to the *Software Setup* section of the *Controller Software* section of the *PreciseFlex Library*.

In addition to the following table of Encoder Connections, refer to [Installation Information](#) for important recommendations on the use of twisted pair wires and shield grounding.

Table 5-1: Encoder Connections

Tamagawa Motor Pin	Wire Color	Signal Name	GSB Connector Pin
A4	BROWN	BATTERY+	4
B4	BROWN/BLACK	BATTERY -	7
B6	BLACK	FG	1
A3	BLUE	PS+	5
B3	BLUE/BLACK	PS-	9
A5	RED	VCC	10

Tamagawa Motor Pin	Wire Color	Signal Name	GSB Connector Pin
B5	BLACK	GND	7

[Table 5-2](#) lists the wiring instructions for the Motor Power Connectors.

Table 5-2: Wiring Instructions for the Motor Power Connectors

Motor Connector Pin	Wire Color	Signal Name	GSB Connector Pin
1	RED	U	6
2	WHITE	V	2
3	BLACK	W	3
4	GREEN	GND	5
1	YELLOW	BRAKE+	1
2	YELLOW	BRAKE-	4

If the encoder is to be used in absolute mode, a battery must be connected to the [Abs Encoder Battery Connector](#). Refer to the information on that connector for detailed pin outs and plug types. [Table 5-3](#) contains information on the required battery power.

Table 5-3: Required Battery Power

External Battery Specification	
Maximum voltage	4.75V
Typical voltage	3.6V
Alarm trigger voltage	3.1V
Current for each encoder	3.6 uA

Appendix A: Product Specifications

Table 6-1: Guidance Slave Board (GSB) Specifications

General Specification	Range & Features
Interface to Master Guidance Controller	
Communications Interface	Interfaces via a two-wire, bi-directional, daisy chained RS-485 line and can be located up to approximately 6 meters away from the controller.
Communications Protocol	Operates as part of the PreciseFlex Servo Network.
Motion Setpoint Command Rate	Motion setpoints commands and higher level returned sampled data are updated at the rate set by the "Trajectory Generator update period in sec" (DataID 600) of the master controller. This update rate is typically 1-4 msec.
Number of units	A combination of up to eight (8) GSBs and GIOs can theoretically be simultaneously interfaced to a Guidance Controller. The actual maximum is a function of the "Trajectory Generator update period in sec" (DataID 600) of the master controller and the available 24VDC power. In typical systems, a maximum of four (4) GSB or GIO boards can be simultaneously operated.
Motion Control	
Motor Drive	One drive: 10.31A peak/4A RMS/5.6A stall Bus voltage & total power: 12VDC to 48VDC Suitable for up to 100W low voltage motors or 200W motors with reduced peak speeds.
Position Sensors Interface	One differential or single-ended digital quadrature encoder interface (factory configured) Support for selected absolute encoders
Control Signals	Brake signal (Up to 1A at 24VDC available for releasing motor brake)
Input and Output Interfaces	
Digital Input Channels	3 optically isolated digital inputs configured as sinking 5VDC to 24VDC for logic high

General Specification	Range & Features
Digital Output Channels	3 optically isolated digital outputs configured as sourcing 24VDC maximum pull up
General	
Size and Weight	70mm (W) x 75mm (L) x 16.2mm (H), 0.040 kg
Low Voltage Logic Power	24VDC required for logic and input/output functions
	A minimum of 0.05 Amps is required for the GSB's logic power. A maximum of 0.3 Amps additional is required when all 3 digital outputs are driving 100mA each. If the digital outputs are driving less than 100ma each, the additional 0.3 Amps will be reduced accordingly. In a typical system, sourcing outputs normally drive 20mA to 50mA. If the board is configured to drive the motor from the 24VDC logic power or if the motor has a brake, the additional power must be factored into the current requirements.

GSBs must be installed in a clean, non-condensing environment with the following specifications.

Table 6-2: Guidance Slave Board Environmental Specifications

General Specification	Range & Features
Ambient temperature	5°C to 40°C
Storage and shipment temperature	-25°C to +55°C
Humidity range	5 to 90%, non-condensing
Altitude	Up to 3000m
Free space around controller	6mm sides and top
Chassis protection class	IP20 (NEMA Type 1)
For EU or EEA countries	IP22 minimum, must meet EN 60204 (IEC 204)