



PreciseFlex™ 100 Robot

User Manual

Part Number 603988, Revision A



Brooks Automation

Information provided within this document is subject to change without notice, and although believed to be accurate, Brooks Automation assumes no responsibility for any errors, omissions, or inaccuracies.

AcuLigner™, Advan Tag™, AutoTeach™, ATR™, AXM™, BiSymmetrik™, CenterSmart™, Crate to Operate™, CrossingConnect™, DARTS™, Enera™, e-RMA™, e-Spares™, e-Volution™, Falcon™, FIXLOAD™, FrogLeg™, GuardianPro™, Independent Twin Linear Exchange™, InCooler™, InLigner™, Isoport™, ITLX™, Jet™, Jet Engine™, LEAP™, LeapFrog™, LowProfile™, LPT™, M2 Nano™, Marathon 2, Marathon Express, PASIV™, Pathway™, PowerPak™, PowerTools™, PuroMaxx™, QuadraFly™, Radius™, Radiant™, Radiant Express™, Reliance™, Reliance ATR™, RetroEase™, SCARA™, SmartPM™, SMIF-INX™, SMIF-LPT™, SPOTLevel™, The New Pathway to Productivity™, Time Optimized Trajectory™, Time Optimal Trajectory™, Time Optimized Path™, TopCooler™, TopLigner™, VacuTran™, VersaPort™, WaferEngine™, LEAP™, Pathway™, GIO, GSB, Guidance 6600, Guidance 6430, Guidance 6420, Guidance 6410, Guidance 6000, Guidance 3400, Guidance 3300, Guidance 3200, Guidance 2600, Guidance 2400, Guidance 2300, Guidance 2200, Guidance 1400, Guidance 1300, Guidance 1200, Guidance 0200 Slave Amplifier, Guidance 0006, Guidance 0004, Guidance Controller, Guidance Development Environment, GDE, Guidance Development Suite, GDS, Guidance Dispense, Guidance Input and Output Module, Guidance Programming Language, GPL, Guidance Slave Board, Guidance System, Guidance System D4/D6, PreciseFlex™ 300, PreciseFlex™ 400, PreciseFlex™ 3400, PreciseFlex™ 1300, PreciseFlex™ 1400, PreciseFlex™ DD4, PreciseFlex™ DD6, PreciseFlex™ DDR, PreciseFlex™ G5400, PreciseFlex™ G5600, PreciseFlex™ G6400, PreciseFlex™ G6410, PreciseFlex™ G6420, PreciseFlex™ G6430, PreciseFlex™ G6600, PreciseFlex™ GSBP Slave Amp, PreciseFlex™ PFD0, PrecisePlace 100, PrecisePlace 0120, PrecisePlace 0130, PrecisePlace 0140, PrecisePlace 1300, PrecisePlace 1400, PrecisePlace 2300, PrecisePlace 2400, PrecisePower 300, PrecisePower 500, PrecisePower 1000, PrecisePower 2000, PreciseVision, and RIO logos are trademarks of Brooks Automation.

Fusion®, Guardian®, MagnaTran®, Marathon®, Razor®, Spartan®, Vision®, Zaris®, and the Brooks and design logo are registered U.S. trademarks of Brooks Automation.

All other trademarks are properties of their respective owners.

© 2024 Brooks Automation. All rights reserved. The information included in this manual is proprietary information of Brooks Automation, and is provided for the use of Brooks customers only and cannot be used for distribution, reproduction, or sale without the express written permission of Brooks Automation.

This technology is subject to United States export Administration Regulations and authorized to the destination only; diversion contrary to U.S. law is prohibited.

<p>Brooks Automation 15 Elizabeth Drive Chelmsford, MA 01824-2400 Tel: +1 978-262-2400 Fax: +1 978-262-2500</p>	<p>Brooks Automation, PreciseFlex Collaborative Robots 201 Lindbergh Avenue Livermore, CA 94551 Tel: +1-408-224-2838</p>
--	---



Worldwide Headquarters

15 Elizabeth Drive
Chelmsford, MA 01824 U.S.A.

Brooks Automation, PreciseFlex Collaborative Robots

201 Lindbergh Avenue
Livermore, CA 94551 U.S.A

Technical Support

Location	Contact	Website
North America	+1-800-447-5007 (Toll-Free) +1-978-262-2900 (Local) +1-408-224-2838 (PreciseFlex™)	
Europe	support_preciseflex@brooksautomation.com	
Japan	+81 120-255-390 (Toll Free) +81 45-330-9005 (Local)	
China	+86 21-5131-7066	http://www.brooks.com/
Taiwan	+886 080-003-5556 (Toll Free) +886 3-5525258 (Local)	
Korea	1800-5116 (Toll Free)	
Singapore	+65 1-800-4-276657 (Toll Free) +65 6309 0701 (Local)	

General Emails

Division	Email Address
Sales	sales_preciseflex@brooksautomation.com
Technical Support	support_preciseflex@brooksautomation.com
Technical Publications	Technical.Publications@brooksautomation.com



Brooks Automation
15 Elizabeth Drive
Chelmsford, MA
01824-2400
Tel: +1 978-262-2400
Fax: +1 978-262-2500
www.brooks.com

Brooks Locations Worldwide:

Brooks Automation
46702 Bayside Parkway
Fremont, CA 94538
Tel: +1-510-661-5000
Fax: +1-510-661-5166

Brooks Automation
AIM Servicios Administrativos
S de RL de CV
Carretera Huinalá km 2.8
Parque Industrial Las Américas
66640 Apodaca, NL Mexico
Tel: +52 81 8863-6363

**Brooks Automation
(Germany) GmbH**
Ernst-Ruska-Ring 11
07745 Jena, Germany
Tel: +49 3641 4821 100
Fax: +49 3641 4821 4100

**Brooks Automation
(Germany) GmbH**
Daimler-Straße 7
78256 Steißlingen, Germany
Tel: +49-7732-9409-0
Fax: +49-7732-9409-200

Brooks Automation
9601 Dessau Road, Suite 301
Austin, TX 78754
Tel: +1 512-912-2840
Toll-Free: +1 800-367-4887

**Brooks Automation
(Israel) Ltd.**
Mevo Yerach 5
Kiryat-Gat 82000
Israel
Tel: +972 8672 2988
Fax: +972 8672 2966

**Brooks Technology (Shanghai)
Limited**
2nd Floor, No. 72,
887 Zuchongzhi Road
Zhangjiang Hi-Tech
Park Pudong, Shanghai
China 201203
Tel: +86-21-5131-7070
Fax: +86-21-5131-7068

Brooks Japan K.K.
HEADQUARTERS
Nisso Bldg. No 16, 9F
3-8-8 ShinYokohama, Kohoku-ku
Yokohama, Kanagawa 222-0033
Tel: +81-45-477-5570
Fax: +81-45-477-5571

Brooks Japan K.K.
YOKOHAMA TECHNICAL
CENTER
852-1 Kawamuko-cho, Tsuzuki-ku
Yokohama, Kanagawa 224-0044
Tel: +81-45-477-5250
Fax: +81-45-470-6800

Brooks Japan K.K.
KUMAMOTO SERVICE OFFICE
202 Mirai Office II
312-1 Tatsudamachi Yuge
Tatsuda, Kumamoto 861-8002
Tel: +81-96-327-9720
Fax: +81-96-327-9721

Brooks CCS Japan K.K.
CONTAMINATION CONTROL
SOLUTIONS
Nisso Bldg. No 16, 9F
3-8-8 ShinYokohama, Kohoku-ku
Yokohama, Kanagawa 222-0033
Tel: +81-45-477-5570
Fax: +81-45-477-5571

Brooks Automation Ltd.
TAIWAN HEADQUARTERS
5F-5, No.32, Tai-Yuen Street
Chu-Pei City
Hsinchu County 302, Taiwan,
R.O.C.
Tel: +886-3-552 5258
Fax (G&A): +886-3-552 5255
Fax (Sales): +886-3-552 5200

Brooks Automation Korea, Inc.
#35 Giheungdanji-Ro 121Beon-
Gil
Giheung-Gu, Yongin-Si
Gyeonggi-Do, 17086
Korea
Tel: +82-31-288-2500
Fax: +82-31-287-2111

**Brooks Automation CCS RS
AG**
Lohstampfstrasse 11
CH-8274 Tägerwilen, Switzerland
Tel: + 41 71-666-72-10
Fax: + 41 71-666-72-11

Brooks Automation Korea
#35 Giheungdanji-Ro 121Beon-
Gil
Giheung-Gu, Yongin-Si
Gyeonggi-Do, 17086
Korea
Tel: +82-31-288-2500
Fax: +82-31-287-2111

Brooks Automation (S) Pte Ltd
51-18-C1 Menara BHL,
57 Jalan Ahmad Shah,
10050, Penang,
Malaysia
Tel: +60 4 3701012
Fax: +60 4 3701015

**Brooks Automation
(Singapore) Pte Ltd**
Blk 5008 Ang Mo Kio Avenue 5
#05-08, Techplace II
Singapore 569874
Tel: +65-6836-3168
Fax: +65-6836-3177

Brooks Automation Ltd.
TAINAN OFFICE
3F., No.11, Nanke 3rd Rd., Xinshi
Dist.
Tainan Science Park
Tainan City 74147, Taiwan
(R.O.C.)
TEL: +886-6-505-0268
FAX: +886-6-505-5228

**Brooks Automation
Precise Collaborative Robotics**
201 Lindbergh Drive
Livermore, CA 94551
Tel: +1-978-262-2400

Revision History

Revision	ECO	Date	Action	Author
A	EC144813	07/24/2023	Released manual at Rev. A to follow standard Brooks technical publication styles.	M. Ashenfelder

Table of Contents

1. Safety	9
Safety Setup	9
Authorized Personnel Only	9
Explanation of Hazards and Alerts	10
Safety Text	10
Safety Icons	10
Signal Words and Color	10
Alert Example	11
General Safety Considerations	12
Mechanical Hazards	14
Electrical Hazards	15
Ergonomic Hazards	16
Emergency Stop Circuit (E-Stop)	18
Recycling and Hazardous Materials	18
2. Introduction to the Hardware	19
Overview	19
System Diagram and Coordinate Systems	20
System Components	22
Optional Gripper	22
Guidance 1400A Controller	22
Low Voltage Power Supplies	23
Energy Dump Circuit	23
Remote Front Panel, E-Stop Box and Manual Control Pendant	23
Optional RS485 IO Module (GIO)	24
Remote IO Module (Ethernet Version)	24
Machine Vision Software and Cameras	25
Machine Safety	26
Safety and Agency Certifications	26
Standards Compliance and Agency Certifications	26
Moving Machine Safety	26
Safety Zones	27
Voltage and Power Considerations	32
3. Installation Information	35
Environmental Specifications	35
Facilities Connections	35
Specifications and System Dimensions	35
Unpacking and Handling Instructions	45
Mounting Instructions	45
Tool Mounting	46
Accessing the Robot Controller	46
Power Requirements	46
Emergency Stop	47
4. Hardware Reference	48



System Schematics, Diagram, and Power Supplies	48
Robot Inputs and Outputs	60
Robot Interfaces	60
MCP/E-Stop Interface	61
Digital Input Signals	62
Digital Output Signals	63
Gripper Controller Digital Inputs and Outputs	65
RS485 Remote IO Module (GIO)	66
Ethernet Interface	68
RS-232 Serial Interface	68
5. Software Reference	69
Accessing the Web Server	69
Loading a Project (Program) or Updating PAC Files	71
Updating GPL (System Software) or FPGA (Firmware)	72
Recovering from Corrupted PAC Files	73
Controller Software Extensions	75
Controlling the PreciseFlex Servo Gripper	76
Overview	76
Software Revision	76
Controlling the Gripper	76
Gripper Squeeze (Simple Method)	77
Gripper Squeeze (Asymmetric Method)	77
Grip Test and Squeeze Check	78
Servo Gripper Controller Digital Inputs and Outputs	79
Optional Pneumatic or Vacuum Gripper	80
Control of Status Lamp on Theta Cover	80
6. Service Procedures	81
Recommended Tools	81
Troubleshooting	81
Encoder Operation Error	83
Replacing the Encoder Battery	84
Calibrating the Robot: Setting the Encoder Zero Positions	86
Replacing Belts and Motors	90
General Belt Tensioning	90
Tensioning the X-axis Belt	91
Replacing the X-axis Motor Assembly	93
Replacing the X-axis Timing Belt	94
Tensioning the Z-axis Output Belt	97
Tensioning or Replacing the Z-axis Motor and Timing Belt	98
Replacing the Theta Axis Motor	99
Replacing the Power Supplies or Controller	101
Replacing the Main Harness	103
Replacing the Servo Gripper Controller	104
Wiring for Pneumatic Gripper	106
Replacing the Gripper Spring or Cable	108
Adjusting the Gripper Backlash	109

Replacing the Gripper Harness	110
Replacing the Gripper	111
Installing the Optional GIO Board	113
Appendices	116
Appendix A: Product Specifications	116
Appendix B: Environmental Specifications	118
Appendix C: Spare Parts List	119
Appendix D: Preventive Maintenance	120
Appendix E: Belt Tensions, Gates Tension Meter	121
Appendix F: Facilities Panel	123

1. Safety

Safety Setup

Brooks uses caution, warning, and danger labels to convey critical information required for the safe and proper operation of the hardware and software. Read and comply with all labels to prevent personal injury and damage to the equipment.

 DANGER Read the Safety Chapter	
<p>Failure to review the <i>Safety</i> chapter and follow the safety warnings can result in serious injury or death.</p> <ul style="list-style-type: none">• All personnel involved with the operation or maintenance of this product must read and understand the information in this safety chapter.• Follow all applicable safety codes of the facility as well as national and international safety codes.• Know the facility safety procedures, safety equipment, and contact information.• Read and understand each procedure before performing it.	

Authorized Personnel Only

This product is intended for use by trained and experienced personnel. Operators must comply with applicable organizational operating procedures, industry standards, and all local, regional, national, and international laws and regulations.

Explanation of Hazards and Alerts

This manual and this product use industry standard hazard alerts to notify the user of personal or equipment safety hazards. Hazard alerts contain safety text, icons, signal words, and colors.

Safety Text

Hazard alert text follows a standard, fixed-order, three-part format.





- Identify the hazard
- State the consequences if the hazard is not avoided
- State how to avoid the hazard.

Safety Icons

- Hazard alerts contain safety icons that graphically identify the hazard.
- The safety icons in this manual conform to ISO 3864 and ANSI Z535 standards.

Signal Words and Color

Signal words inform of the level of hazard.

	<p>Danger indicates a hazardous situation which, if not avoided, will result in serious injury or death.</p> <p>The Danger signal word is white on a red background with an exclamation point inside a yellow triangle with black border.</p>
	<p>Warning indicates a hazardous situation which, if not avoided, could result in serious injury or death.</p> <p>The Warning signal word is black on an orange background with an exclamation point inside a yellow triangle with black border.</p>
	<p>Caution indicates a hazardous situation or unsafe practice which, if not avoided, may result in minor or moderate personal injury.</p> <p>The Caution signal word is black on a yellow background with an exclamation point inside a yellow triangle with black border.</p>
	<p>Notice indicates a situation or unsafe practice which, if not avoided, may result in equipment damage.</p> <p>The Notice signal word is white on blue background with no icon.</p>



Alert Example

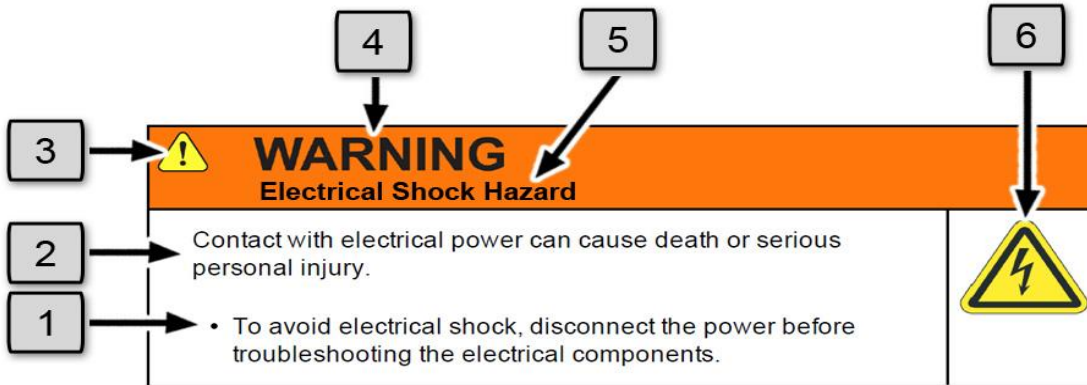

The following is an example of a Warning hazard alert.







Number	Description
1.	How to Avoid the Hazard
2.	Source of Hazard and Severity
3.	General Alert Icon
4.	Signal Word
5.	Type of Hazard
6.	Hazard Symbol(s)



General Safety Considerations



 WARNING Software	
<p>Software is not safety rated. Unplanned motion can occur as long as power is supplied to the motors. Maximum torque could be momentarily applied that may cause equipment damage or personal injury.</p> <ul style="list-style-type: none">• Only operate the robot with its covers installed.• Guarantee that safety controller features are in place (for example, an emergency stop button and protective stop).• Regularly test safety components to prove that they function correctly.	 



 WARNING Robot Mounting	
<p>Before applying power, the robot must be mounted on a rigid test stand, secure surface, or system application. Improperly mounted robots can cause excessive vibration and uncontrolled movement that may cause equipment damage or personal injury.</p> <ul style="list-style-type: none">• Always mount the robot on a secure test stand, surface, or system before applying power.	



 WARNING Do Not Use Unauthorized Parts	
<p>Using parts with different inertial properties with the same robot application can cause the robot's performance to decrease and potentially cause unplanned robot motion that could result in serious personal injury.</p> <ul style="list-style-type: none">• Do not use unauthorized parts.• Confirm that the correct robot application is being used.	

 WARNING Magnetic Field Hazard	
<p>This product contains magnetic motors that can be hazardous to implanted medical devices, such as pacemakers, and cause personal harm, severe injury, or death.</p> <ul style="list-style-type: none">• Maintain a safe working distance of 30 cm from the motor when with an energized robot if you use a cardiac rhythm management device.	



 CAUTION Unauthorized Service	
<p>Personal injury or damage to equipment may result if this product is operated or serviced by untrained or unauthorized personnel.</p> <ul style="list-style-type: none">• Only qualified personnel who have received certified training and have the proper job qualifications are allowed to transport, assemble, operate, or maintain the product.	

 CAUTION Damaged Components	
<p>The use of this product when components or cables appear to be damaged may cause equipment malfunction or personal injury.</p> <ul style="list-style-type: none">• Do not use this product if components or cables appear to be damaged.• Place the product in a location where it will not get damaged.• Route cables and tubing so that they do not become damaged and do not present a personal safety hazard.	



 CAUTION Inappropriate Use	
<p>Use of this product in a manner or for purposes other than for what it is intended may cause equipment damage or personal injury.</p> <ul style="list-style-type: none">• Only use the product for its intended application.• Do not modify this product beyond its original design.• Always operate this product with the covers in place.	

 CAUTION Seismic Restraint	
<p>The use of this product in an earthquake-prone environment may cause equipment damage or personal injury.</p> <ul style="list-style-type: none">• The user is responsible for determining whether the product is used in an earthquake prone environment and installing the appropriate seismic restraints in accordance with local regulations.	

Mechanical Hazards

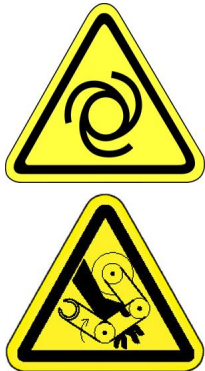

 CAUTION Pinch Point	
<p>Moving parts of the product may cause squeezing or compression of fingers or hands resulting in personal injury.</p> <ul style="list-style-type: none">• Do not operate the product without the protective covers in place.	



 WARNING Automatic Movement	
<p>Whenever power is applied to the product, there is the potential for automatic or unplanned movement of the product or its components, which could result in personal injury.</p> <ul style="list-style-type: none">• Follow safe practices for working with energized products per the facility requirements.• Do not rely on the system software or process technology to prevent unexpected product motion.• Do not operate the product without its protective covers in place.• While the collaborative robotics system is designed to be safe around personnel, gravity and other factors may present hazards and should be considered.	



 CAUTION Vibration Hazard	
<p>As with any servo-based device, the robot can enter a vibratory state resulting in mechanical and audible hazards. Vibration indicates a serious problem. Immediately remove power.</p> <ul style="list-style-type: none">• Before energizing, ensure the robot is bolted to a rigid metal chamber or stand.	

Electrical Hazards

Refer to the specifications of the *Guidance Controller Quick Start Guide* for the electrical power.



 DANGER Electrical Shock Hazard	
<p>Contact with electrical power can cause personal harm and serious injury.</p> <ul style="list-style-type: none">• To avoid electrical shock, disconnect the power before troubleshooting the electrical components.• Check the unit's specifications for the actual system power requirements and use appropriate precautions.• Never operate this product without its protection covers on.	



 WARNING Electrical Burn	
<p>Improper electrical connection or connection to an improper electrical supply can result in electrical burns resulting in equipment damage, serious injury, or death.</p> <ul style="list-style-type: none">• Always provide the robot with the proper power supply connectors and ground that are compliant with appropriate electrical codes.	



 WARNING Electrical Fire Hazard	
<p>All energized electrical equipment poses the risk of fire, which may result in severe injury or death. Fires in wiring, fuse boxes, energized electrical equipment, computers, and other electrical sources require a Class C extinguisher.</p> <ul style="list-style-type: none">• Use a fire extinguisher designed for electrical fires (Class C in the US and Class E in Asia).• It is the facility's responsibility to determine if any other fire extinguishers are needed for the system that the robot is in.	

NOTICE
<p>Improper handling of the power source or connecting devices may cause component damage or equipment fire.</p> <ul style="list-style-type: none">• Connect the system to an appropriate electrical supply.• Turn off the power before servicing the unit.• Turn off the power before disconnecting the cables.

Ergonomic Hazards



 CAUTION Heavy Lift Hazard	
<p>Failure to take the proper precautions before moving the robot could result in back injury and muscle strain.</p> <ul style="list-style-type: none">• Use a lifting device and cart rated for the weight of the drive or arm.• Only persons certified in operating the lifting device should be moving the product.	

 CAUTION Tipover Hazard	
<p>This product has a high center of gravity which may cause the product to tip over and cause serious injury.</p> <ul style="list-style-type: none">• Always properly restrain the product when moving it.• Never operate the robot unless it is rigidly mounted.	

 CAUTION Trip Hazard	
<p>Cables for power and communication and facilities create trip hazards which may cause serious injury.</p> <ul style="list-style-type: none">• Always route the cables where they are not in the way of traffic.	

Emergency Stop Circuit (E-Stop)

The integrator of the robot must provide an emergency stop switch.

 WARNING Emergency Stop Circuit	
<p>Using this product without an emergency stop circuit may cause personal injury.</p> <ul style="list-style-type: none">• Customer is responsible for integrating an emergency stop circuit into their system.• Do not override or bypass the emergency stop circuit.	

Recycling and Hazardous Materials

Brooks Automation complies with the EU Directive 2002/96/EU Waste Electrical and Electronic Equipment (WEEE).

The end user must responsibly dispose of the product and its components when disposal is required. The initial cost of the equipment does not include cost for disposal. For further information and assistance in disposal, please email Brooks Automation Technical Support at support@preciseflex@brooksautomation.com.

2. Introduction to the Hardware

Overview

The PrecisePlace 100 Robot is a collaborative 4-axis robot that includes an embedded Guidance 1400 A 4-axis motion controller, one or more single axis controllers, a 48 VDC motor power supply, and a 24 VDC logic power supply located inside the X-axis of the robot. In addition, it may optionally include an electric gripper and electric gripper controller.

The robot is available in an XZ configuration, with a theta rotation and electric gripper. The Z-axis is available with a standard travel of 229 mm for the XZ configuration. The robot is designed as tabletop unit and can carry a payload of up to 2 kg in the gripper. These robots are low cost, extremely quiet and smooth, very reliable, and have excellent positioning repeatability. To achieve these results, the axes are powered by brushless DC motors with absolute encoders. With these characteristics, these robots are ideal for automating applications in the Life Sciences, Medical Products, Semiconductor, and Electronics industries.

A number of communications and hardware interfaces are provided with the basic robot. These include an RS-232 serial interface, an RS485 serial interface, an Ethernet interface, and a number of digital input and output lines. In addition, the robot can be purchased with several types of optional Precise peripherals. These include digital cameras, remote I/O, and a hardware manual control pendant.

The controller is programmed by means of a PC connected through Ethernet. There are four programming modes: a Digital IO mode (MotionBlocks), a Graphical Programming mode (Guidance Motion), an Embedded Language mode (GPL), and a PC Control mode (TCP Command Server). When programmed in the MotionBlocks, Guidance Motion, or GPL mode, the PC can be removed after programming is completed and the controller will operate standalone. The PC is required for operation in the TCP Command Server mode.

In all modes of operation, the controller includes a web-based operator interface. This interface is used for configuring the system, starting and stopping execution, and monitoring its operation. The web interface can be accessed locally using a browser or remotely via the Internet. This remote interface is of great benefit in system maintenance and debugging. It is also possible to use a wireless tablet or computer to access the web browser, if the controller is connected to a wireless router.

The optional machine vision system, "PreciseVision," can execute in a PC connected through Ethernet or in an embedded PC inside the robot. PreciseVision requires cameras connected via Ethernet or USB, allowing any processor on the network to obtain and process information from any camera on the network, and provide the results to any networked motion controller.

System Diagram and Coordinate Systems

The PrecisePlace 100 robot is available in several configurations, including XZ, XZTheta, and XZTheta+Gripper. The orientation and origin of its World Cartesian coordinate system are shown in the graphic below and defined in the table.

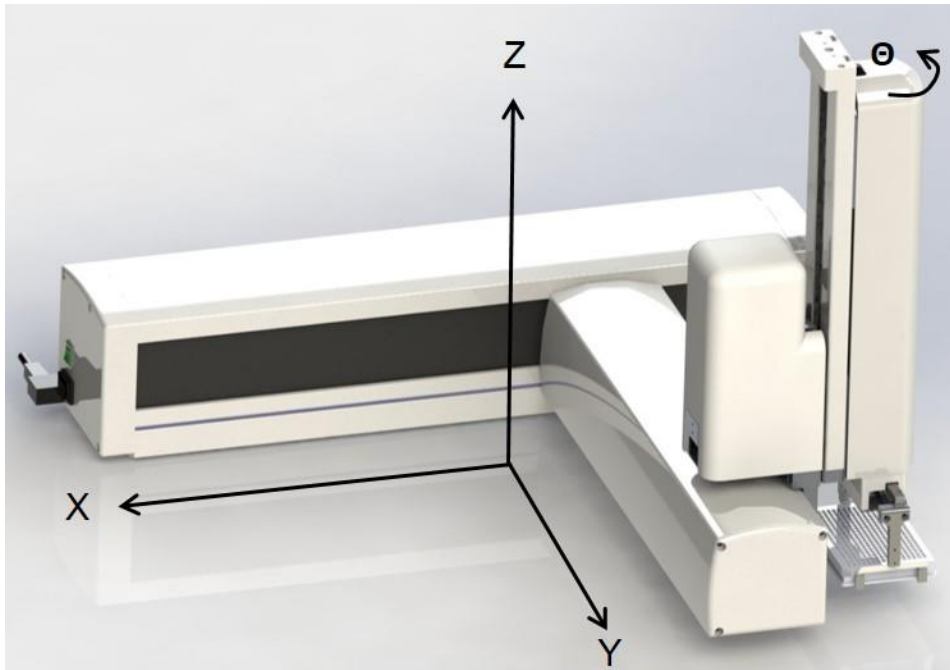

Figure 2-1: PrecisePlace 100 Orientation & Origin of Its World Cartesian Coordinate System

Table 2-1: Axis & Description of Motion

Axis	Description of Motion
X	Varies with model
Z	229 mm XZ

Axis	Description of Motion
Theta	+/- 270 degrees
Gripper	76 to 136 mm

The first axis of the robot is the X-axis. When the carriage is closest to the right end, the X-axis is at its 0 position in the Joint Coordinate system and in the World Coordinate system. As the robot arm moves to the left, both its joint position and the World X Coordinate increase in value.

The X Extrusion also contains the 24 VDC and 48 VDC power supplies and the controller, as well as a connector panel in the end cap. When the gripper is installed, the gripper controller is located on the Z extrusion.

The second axis of the robot is the Z-axis. Note for the Z-axis, the positive direction is upwards in the World Coordinate system and downwards in the Joint Coordinate system.

The third axis is the theta axis and rotates the gripper about the World Z-axis. A positive change in the axis angle results in a positive rotation about the World Z-axis following the right-hand rule.

The robot may include an optional electric gripper, along with a gripper controller. It is also possible to order the robot with a pneumatic gripper, in which case the outer link will house a solenoid to control air to the pneumatic gripper. A light bar is mounted at the top of the theta cover and blinks at a rate of once per second to indicate that the controller is operational and at a rate of 4 times a second when power is being supplied to the motors.

The Z-axis includes a fail-safe brake. This brake must be released to move the Z-axis up and down manually. There is a manual brake release button at the back of the Z-axis drive cover. Depressing this button when 24VDC power is on will release the Z-axis brake while the button is depressed. It is not necessary for the control system to be operating for the brake release to function; the only requirement is providing 24VDC to the controller. Care should be taken to support the Z-axis when the brake release button is pushed, as the axis will fall due to gravity.

System Components

Optional Gripper

The robot may be ordered with a servo Gripper. It may also be ordered without a gripper.

Guidance 1400A Controller

The Guidance 1400A Controller is a 4-axis general purpose motion controller that contains four motor drives and four encoder inputs. It must be attached to a heat sink. The heat sink is provided by sheet metal in the X extrusion. The controller includes local digital IO. It also supports RS232 and RS 485 serial communication and an optional PreciseFlex Remote IO module. It contains two Ethernet ports. The controller and power supplies are shown in [Figure 2-2](#).

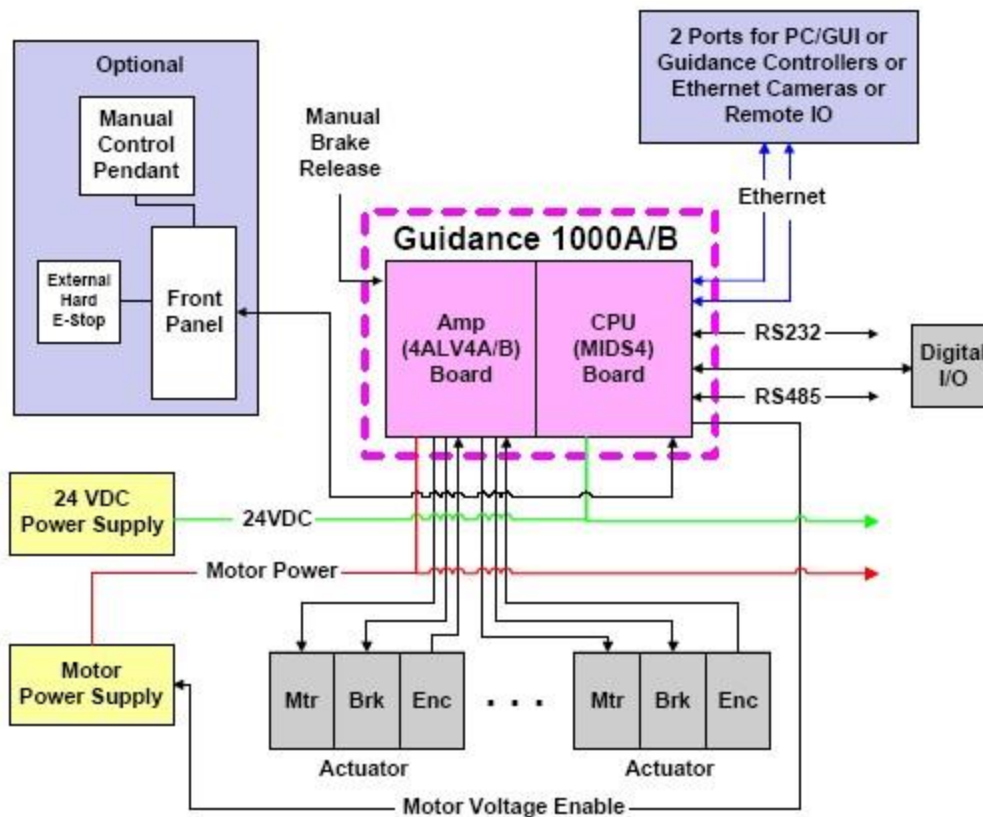



Figure 2-2: System Diagram

For detailed information on the controller including interfacing information, see the *Guidance 1000A/B Controllers Manual* (P/N: G1X0-DI-A0010).

Low Voltage Power Supplies

The PreciseFlex 100 Robot has an integrated 125-Watt, 24VDC Power Supply that accepts a range of AC input from 90V to 264V and an integrated 365W, 48VDC Power Supply for the motors.

 DANGER Electrical Shock Hazard	
Contact with electrical power can cause death or serious personal injury. <ul style="list-style-type: none">To avoid electrical shock, disconnect the power before troubleshooting the electrical components.In addition to exposed high voltage pins and components, the heat sinks on the Power Supplies are not grounded and expose high voltage levels. Disconnect AC power to the robot prior to accessing these units.	

Energy Dump Circuit

The 48VDC supply has a regulated output and an overvoltage protection circuit that is triggered if the voltage reaches 60 Volts. Rapid deceleration of the robot motors can generate a Back EMF voltage that can pump up the motor voltage bus. In order to avoid bus pump up, an Energy Dump Circuit is connected to the 48VDC bus, and a regeneration resistor is connected to the controller to dissipate this energy when necessary.

Remote Front Panel, E-Stop Box and Manual Control Pendant

Brooks offers an E-Stop Box ([Figure 2-3](#)) or a portable Hardware Manual Control Pendant ([Figure 2-4](#)) that includes an E-Stop button. The E-Stop box can be plugged into the 9 pin D-sub connector in the connector panel in the base of the robot. The E-Stop box completes a circuit from Pin 6 (24VDC) to Pin 7 (E-Stop) in this connector. If this circuit is not completed it is not possible to enable motor power to the robot. If no E-Stop box or Manual Control Pendant is connected, a jumper must be connected between these two pins to enable robot motor power. The Manual Control Pendants can be plugged directly into the 9-pin Dsub connector mounted on the robot's Facilities Panel in the base of the robot. The E-Stop connections are also present on the 9-pin Dsub connector and each of these units provides the hardware signals to permit power to be enabled and disabled.



Figure 2-3: E-Stop Button



Figure 2-4: Manual Control Pendant

Optional RS485 IO Module (GIO)

An optional IO module (Figure 2-5) can be added at the base of the robot. This module provides 12 digital inputs and 8 digital outputs in a 25-pin Dsub connector at the robot rear panel and is connected via RS485 to the robot controller.

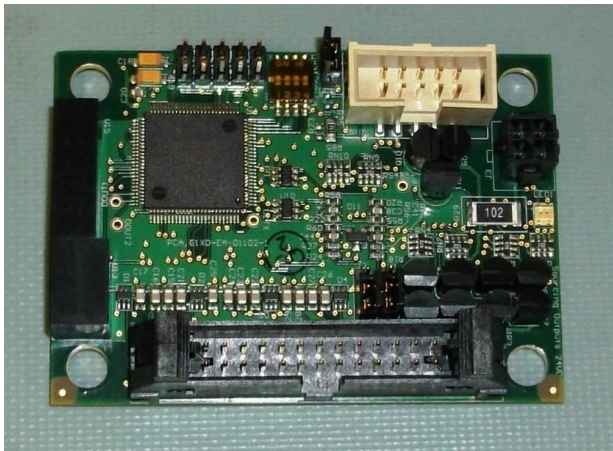

Figure 2-5: Optional Digital IO Module (GIO)



Remote IO Module (Ethernet Version)

For applications that require a large number of Inputs and Outputs, a PreciseFlex Remote IO (RIO) module may be purchased. The RIO interfaces to any PreciseFlex robot and its embedded Guidance Controller via 10/100 Mb Ethernet and requires 24VDC power. Up to four RIOs can be connected to a controller.

The basic RIO includes: 32 isolated digital input signals, 32 isolated digital output signals and one RS-232 serial line. An enhanced version of the RIO (Figure 2-6) adds four analog input signals, a second RS-232 port and one RS-422/485 serial port.



Figure 2-6: Enhanced RIO Module

 WARNING	
<p>The RIO contains unshielded 24VDC signals and pins. This product is intended to be mounted in a cabinet or machine chassis that is not accessible when power is turned on.</p>	

Machine Vision Software and Cameras

The Guidance 1400 Series controllers support the PreciseVision machine vision system. This is a vision software package that can run in a PC.

Cameras must be connected via Ethernet or USB. Vendors such as DALSA already offer a variety of Ethernet machine vision cameras. In addition, other vendors offer USB cameras that are supported in PreciseVision.

Brooks offers an Arm-Mounted Camera Option for certain robots. Contact sales_preciseflex@brooksautomation.com for details.

Machine Safety

Safety and Agency Certifications

PreciseFlex™ systems can include computer-controlled mechanisms that are capable of moving at high speeds and exerting considerable force. Like all robot and motion systems, and most industrial equipment, they must be treated with respect by the user and the operator.

This manual should be read by all personnel who operate or maintain Precise systems, or who work within or near the work cell.

Read EN ISO 10218-2011-1 and -2, Manipulating Industrial Robots – Safety, which contains guidelines for robot system installation, safeguarding, maintenance, testing, startup, and operator training. Also read the International Standard IEC 204 or the European Standard EN 60204, Safety of Machinery – Electrical Equipment of Machines.

Standards Compliance and Agency Certifications

The PreciseFlex™ robots are intended for use with other equipment and are considered a subassembly rather than a complete piece of equipment on their own. They meet the requirements of these standards:

- ENISO 10218-1-2011-1 Robots for Industrial Environments, Safety Requirements
- EN 610204-1 Safety of Machinery, Electrical Equipment of Machines
- EN 61000-6-2 EMC Directive (Immunity)
- EN 61000-6-4 EMC Directive (Emissions)

CSA/UL

CE

To maintain compliance with the above standards the controller must be installed and used in accordance with the regulations of the standards, and in accordance with the instructions in this user's guide.

Moving Machine Safety

The PreciseFlex™ robots can operate in Manual Control Mode, in which an operator directly controls the motion of the robot, or Computer Control Mode in which the robot operation is automatic. Manual Control Mode is often used to teach locations in the robot workspace. The robot's speed is limited in Manual Control Mode to a maximum of 250 mm per second for safety. While the PreciseFlex 100 is a light-duty robot that can only apply approximately 120 Newtons of force (or less in collaborative mode), it is very important for operators to keep their hands, arms and especially their head out of the robot's operating volume, when the robot is running under computer control. It is important that operators wear safety glasses when inside the robot's operating volume.

In Computer Mode the robot can move quickly. The PP100 has been designed to be “hand-safe” even in computer mode, and in some cases a risk assessment of the application may indicate that it can be used without operator safety screens. However safety glasses should be worn at all times when an operator is within the robots working volume. Refer to the EN ISO 10218-2011-1 and -2, for Industrial Robots for information on recommended safe operating practices and enclosure design for robots of various sizes and payloads.

Safety Zones

For all robot types, “Safety Zones” can be defined that disable motor power and halt the motion of the robot if its tool center point (TCP) violates the requirements of a user defined 3D volume.

NOTE: Safety zones are implemented in software only.

Types of Safety Zones

These 3D safety zones can be used to:

1. Approximately model the volume of stationary objects or personnel working areas to prevent the robot from inadvertently entering this volume and causing a collision (“keep out zones”).
2. Reduce the normal working volume of the robot to prevent the robot from reaching beyond prescribed boundaries and causing a collision (“stay within zones”).
3. Verify that the robot’s TCP speed (when in a specified volume) is below a specified limit so that the robot can be safely decelerated and stopped before it might pin an operator’s hand to a hard surface with too high a force (“speed restrict zones”).

As currently implemented, the “keep out zones” and “stay within zones” are provided as general safety features, but they do not meet the stringent Category 3 safety standards that require fail safe redundant logic. However, the “speed restrict zones” do provide the requisite redundancy and are in the process of being Category 3 certified. The “keep out zones” and “stay within zones” are collectively referred to as “uncertified zones” and the “speed restrict zones” are referred to as “certified zones”.

The supported zone shapes are rectangular volumes, cylinders and spheres. To define a safety zone, the type of safety zone must be specified along with its origin and dimensions.

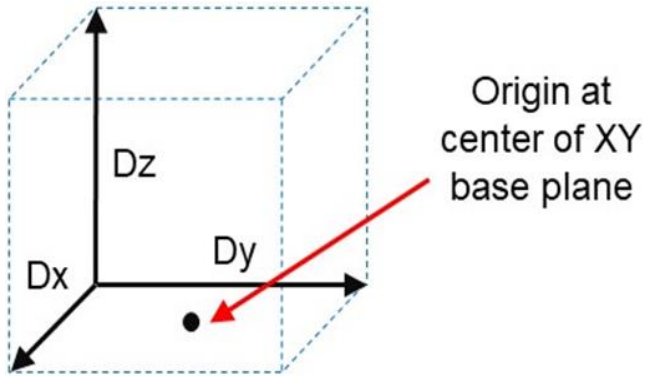

Figure 2-7: Rectangular Volume

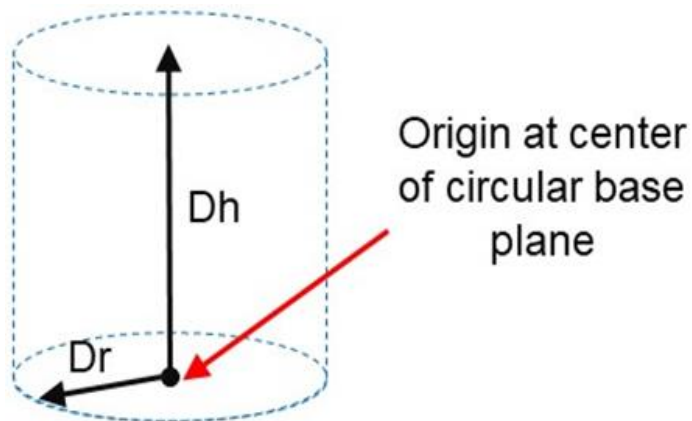

Figure 2-8: Cylinder

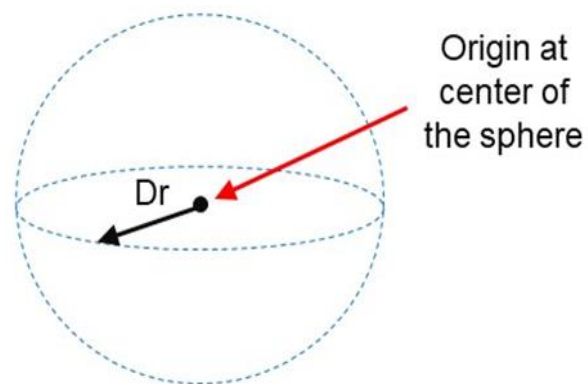

Figure 2-9: Sphere

For increased generality, uncertified zones can be arbitrarily positioned and rotated in all three dimensions. Due to implementation limitations, certified zones must be non-rotated rectangular volumes, which can be arbitrarily positioned. Up to 10 zones can be defined for each robot and any mix of certified and uncertified can be specified. Due to safety requirements, any new or modified zone specifications only go into effect after the controller is rebooted.

Safety Zone Violation Detection and Clearing

Uncertified safety zones are active in the following circumstances:

- Continuously during program-controlled motions of all types (straight line or arc Cartesian and joint interpolated).
- Continuously during manual (jog) control modes: World, Tool and Joint, but not free.
- Motion planning (final destinations only).
- Location object.KineSol method during conversions to either Cartesian or joint Locations.

Certified safety zones are only active during program-controlled motions (of all types) since this is the only circumstance where higher TCP speeds are possible.

When motor power is enabled and the robot's TCP is in violation of an uncertified safety zone, a program-controlled motion cannot be initiated. This condition can be cleared by disabling motor power and manually repositioning the robot or by manually jogging the TCP in World, Tool or Joint modes, so long as the jog motion reduces the safety zone violation distance. That is, jogging motions that increase the violation of a safety zone are not permitted.

NOTE: Safety zone testing is based on the TCP of the robot. Therefore, it is very important that the position of the tool center point relative to the robot's tool mounting flange is set correctly. Please see the Robot.Tool property for information on defining the TCP.

Certified Speed Restrict Safety Zones

While the uncertified safety zones perform conventional tests on just the position of the TCP, there are two certified safety zones and these perform special tests to detect if the speed of the TCP exceeds a limit while the TCP is within the zone. The first certified safety zone tests if the Z downward speed of the TCP exceeds a specified limit. This safety zone was implemented for the PreciseFlex 400 and PreciseFlex 3400 robots since their only intrinsically non-safe motion is a high-speed downward Z motion that could trap a person's hand between the tooltip and a fixed object or horizontal surface. The second certified safety zone tests if the horizontal, XY planar, speed of the TCP exceeds a specified limit. This test was developed for the PreciseFlex™ DD robots since robots can generate excessive speeds when moving horizontally.

For both of these tests, in order to satisfy the computational redundancy requirement of the Category 3 safety regulations, the shapes of these safety zones are limited to non-rotated rectangular volumes.

Please consult the user manuals for these PreciseFlex™ robots for when speed restrict safety zones must be defined to safely operate these mechanisms.

Configuring Safe Zones

Up to 10 safety zones can be defined per robot. Each of these zones is specified by filling in one of the Parameter Database IDs 16900 to 16909, which are labeled "Safety Zone: type, x/y/z/y/p/r, dim 1/2/3". Any combination of certified and uncertified safety zones can be specified. Each of these DataIDs consists of an array of 10 numbers and the first value defines the safety zone "type". Any DataID that has a zero "type" is ignored. [Table 2-2](#) describes the possible safety zone types:

Table 2-2: Safety Zone Types

Safety Zone Type	Description
0.	Undefined safety zone
1.	Rectangular volume, keep out zone
2.	Cylinder, keep out zone
3.	Sphere, keep out zone
4.	Rectangular volume, stay within zone
5.	Cylinder, stay within zone
6.	Sphere, stay within zone
7.	Non-rotated rectangular volume, Z downward speed restrict zone
8.	Non-rotated rectangular volume, XY speed restrict zone

[Table 2-3](#) describes the safety zone DataIDs. When any of these DataIDs are modified, the controller must be rebooted for the change to be put in effect.

Table 2-3: Data IDs

DataID	Parameter Name	Description
16900 to 16909	Safety Zone: type, x/y/z/y/p/r, dim 1/2/3	<p>Each safety zone definition consists of an array of 10 values. The first value is the safety zone “type”. The next six values define the position of the origin of the volume of interest and its orientation. This is specified as a standard Location value:</p> <p style="text-align: center;">x, y, z, yaw, pitch, roll.</p> <p>The final three values define the size of the volume of interest. For the permitted shapes, this is interpreted as:</p> <p style="text-align: center;">volume: Dx, Dy, Dz Cylinder: Dh, Dr, 0 Sphere: Dr, 0, 0</p> <p>For example, for a downward Z non-rotated rectangular volume speed restrict safety zone, a single DataID should be specified as follows:</p> <p style="text-align: center;">7, x, y, z, 0, 0, 0, Dx, Dy, Dz</p> <p>Where x, y, z are the coordinates of the center of the base of the rectangular volume and Dx, Dy, Dz are the dimensions of the volume, all in mm.</p>



In addition, the DataID in [Table 2-4](#) must be initialized to establish the maximum speed limits for the certified safety zones:

Table 2-4: Data IDs

DataID	Parameter Name	Description
2740	Certified safety zone, max Z/XY spd mm/sec	<p>These parameters define the maximum speeds that are permitted for the Certified Speed Restrict Safety Zones. The first value is the maximum downward Z speed (when within the safety zone) in mm/sec. Since this is a downward speed, it should be a negative value and defaults to -200. The second value is the maximum permitted speed in the horizontal XY plane (when within the safety zone), and defaults to 200 mm/sec.</p>

Voltage and Power Considerations

The Guidance 1400A controller requires two DC power supplies, a 24 VDC power supply for the processor and user IO, and a separate 48 VDC motor power supply.

 DANGER Electrical Shock	
<p>Working with energized equipment may cause electrical shock and may result in serious injury or death. The Guidance 1400, the 48 VDC and the 24 VDC power supplies are all open frame electrical devices that contain unshielded high voltage pins, components and surfaces. These products are intended to be mounted in a cabinet or machine chassis that is not accessible when AC line power is turned on.</p> <ul style="list-style-type: none">• Disconnect the AC power before working on the device.	

The robot's power supplies have an input range of 100 to 240 VAC, +/- 10%, 50/60 Hz. Inrush current can be as high as 100 Amps at 240 VAC for short periods of time. The power supplies are protected against voltage surge to 2000 Volts. Transient over voltage (< 50 μ s) may not exceed 2000 V phase to ground, as per EN61800-31996. The power supplies are protected against over current and over voltage conditions.

The robot consumes less than 200 Watts during normal operation. The Precise controller can monitor motor power through its datalogging function. Intermittent power dropouts can be detected by setting a trigger in the data logger which can record and time-stamp power fluctuations.

Mechanical and Software Limit Stops

The X-axis, Z-axis, Theta rotation, and Gripper have hard limit stops at the end of travel which are factory installed. The soft-limit stops must be set within the range of these hard stops. Since the robot has absolute encoders with battery backup on all axes except the gripper, even if the robot is turned off, the encoders keep track of joint position. If any axis is pushed outside of the soft limit stops, the robot will not allow the axis to run under computer control until the axis is moved back inside the software limit stop either under manual control or by hand. The joint position can be viewed either on the optional Manual Control Pendant, or in the Virtual Manual Control Pendant in the Web Based Operator Interface. (See the *Guidance Controller Setup and Operation Quick Start Guide*).

Stopping Time and Distance

The robot control system responds to two types of E-Stops.

A soft E-Stop initiates a rapid deceleration of all robots currently in motion and generates an error condition for all GPL programs that are attached to a robot. This property can be used to quickly halt

all robot motions in a controlled fashion when an error is detected. A soft E-stop is typically generated by an application program under conditions determined by the programmer.

This function is similar to a hard E-Stop except that soft E-Stop leaves High Power enabled to the amplifiers and is therefore used for less severe error conditions. Leaving power enabled is beneficial in that it prevents the robot axes from sagging and does not require high power to be manually re-enabled before program execution and robot motions are resumed. This function is also similar to a Rapid Deceleration feature except that a Rapid Deceleration only affects a single robot and no program error is generated. If set, the **SoftEStop** property is automatically cleared by the system if High Power is disabled and re-enabled.

A hard E-Stop is generated by one of several hardware E-Stop inputs and causes motor power to be disabled. However, there is a parameter that determines a delay between the time the hard E-Stop signal is asserted and the time the motor power supply relay is opened. This delay is nominally set at 0.5 seconds. It may be adjusted by an operator with administrator privileges. On the web-based operator interface menu, go to Setup/Parameter Database/Controller/Operating Mode/ and set parameter 267 to the desired delay. If this delay is set to 0, the high-power relay will be disabled within 1 ms.

For the PrecisePlace 100 robot, the X-axis and Theta rotation axes do not have mechanical brakes. Therefore, leaving the motor power enabled for 0.5 sec allows the servos to decelerate the robot. The servos will typically decelerate the robot at 1.0G, or 10,000 mm/sec². If the robot is moving at a speed of 500 mm/sec, the distance traveled will be 12.5 mm to reach a full stop, and the time will be 0.050 sec. If the robot is moving at its maximum speed of 1500 mm/sec, the time to stop will be about 150 ms and the distance about 110 mm.

Releasing a Trapped Operator: Brake Release Switch

Should a hard E-Stop be triggered, the Z brake will engage, and motor power will be disconnected from all motors. As the J1, J2, and J4 axes have no brakes, they may be freely pushed by the operator. To release the Z brake, press the brake release switch ([Figure 2-10](#)) at the rear of the Z-axis motor cover, as long as 24 VDC is present. It is not necessary for motor power to be on for the brake release to work.



Figure 2-10: Brake Release Switch

3. Installation Information

Environmental Specifications

The PreciseFlex™ robots must be installed in a clean, non-condensing environment. Light fluid splashing around the base of the robot is acceptable, but this robot is not intended for use in a washdown or spray environment. See [Environmental Specifications](#) in Appendix B for specific environmental limits.

Facilities Connections

See [Appendix F: Facilities Panel](#) for details of the Facilities Panel.

Specifications and System Dimensions

Figure 3-1: Specifications, Ranges & Features

General Specifications	Range & Features
Range of Motion & Resolution	
X-axis	<ul style="list-style-type: none">• 500 mm standard• 685 mm standard, 1270 mm option available in XZ version
Z-axis	<ul style="list-style-type: none">• 229 mm standard in XZ version
Theta Axis	+/- 270 degrees

General Specifications	Range & Features
Gripper	<p>An optional integrated servo gripper is available. The servo gripper has 60 mm of travel and can be outfitted with user developed fingers for holding a variety of different size parts.</p> <p>Software can control squeeze force (between approximately 0 -23 N for close force, 0 -10 N for open force) and open/close speed.</p> <p>Safety features include: protection against dropping parts when robot is powered down or e-stop pressed (grripper provides 7 -10 N of c lose force when motor power is off)</p>
Repeatability	+/- 100 µm overall in X and Z directions at 18 -22 degrees C
Performance and Payload	
Maximum Acceleration	1 .0 G with 500 gm payload
Maximum Speed	1 ,500 mm /sec in X
Maximum Payload	2 kg with gripper option. 3 kg with XZ configuration without Theta and gripper
Motors	Brushless DC servo motors with absolute encoders on X , Z, and Theta axes, no motion during homing.
TUV Certified Collaborative Forces	PreciseFlex™ collaborative robots have been measured by TUV and certified to exert forces that fall within the force guidelines for collaborative robots as defined by the recent ISO/TS 15066 Standard on Collaborative Robots. Even maximum speed collisions in free space are well under the ISO force limits for operator safety. However, in order to use a robot in an application without safety shields, the application as a whole (including end effectors, operation methods, objects being handled and obstacles in the workcell) must be evaluated for safety. For more information on the evaluation of applications and workcells without safety shields, please contact Brooks.
Interfaces	
General Communications	RS -232 C interface, 10 /100 M bps Ethernet port, E -stop input, all available on the X-axis end cap
Digital I/O Channels	Four optically isolated inputs and four optically isolated outputs available on X-axis endcap. Option available for an additional 12 optically isolated digital inputs and 8 optically isolated digital outputs on X - axis back cover. Additional remote I/O available via Precise RIO modules or 3 rd party MOD BUS/TCP devices
Operator Interface	Web based operator interface supports local or remote control via browser connected to embedded web server
Programming Interface	Three methods available: Guidance Motion (simple G UI for non-programmers using teach and repeat methods), embedded Guidance Programming Language (standalone, modeled after Visual Basic.Net), PC control using open source TCP/IP Com m and Server operated via Ethernet connection (TCP).
Required Power	The robot's power supplies have a dual input range of 100 to 120 VAC +/- 10% and 200 to 240 VAC, +/- 10%, 50/60 Hz
Weight	20 kg for 635 mm travel version, 32 kg for 1270 mm travel version

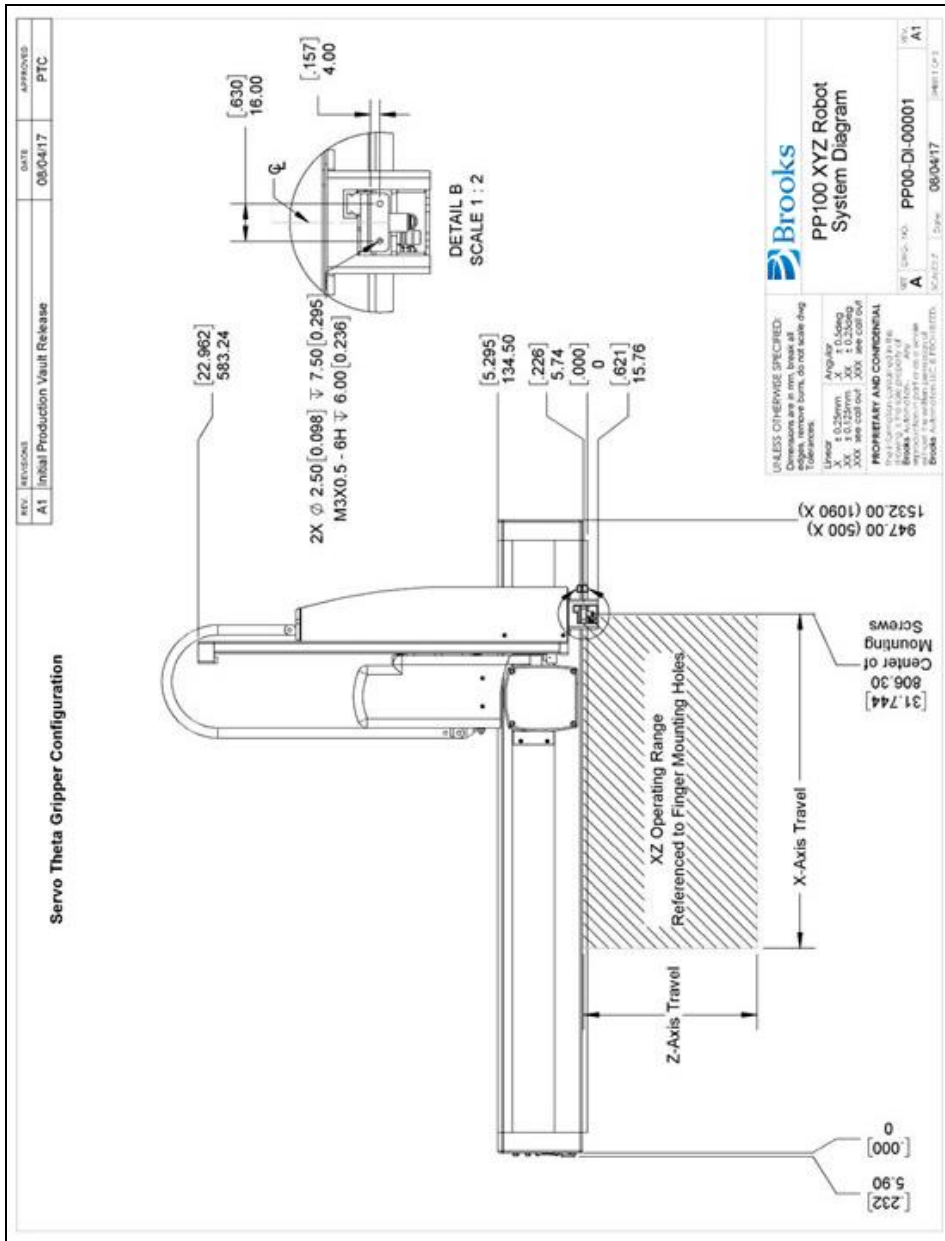

Figure 3-2: XYZ Robot with Gripper, Front View

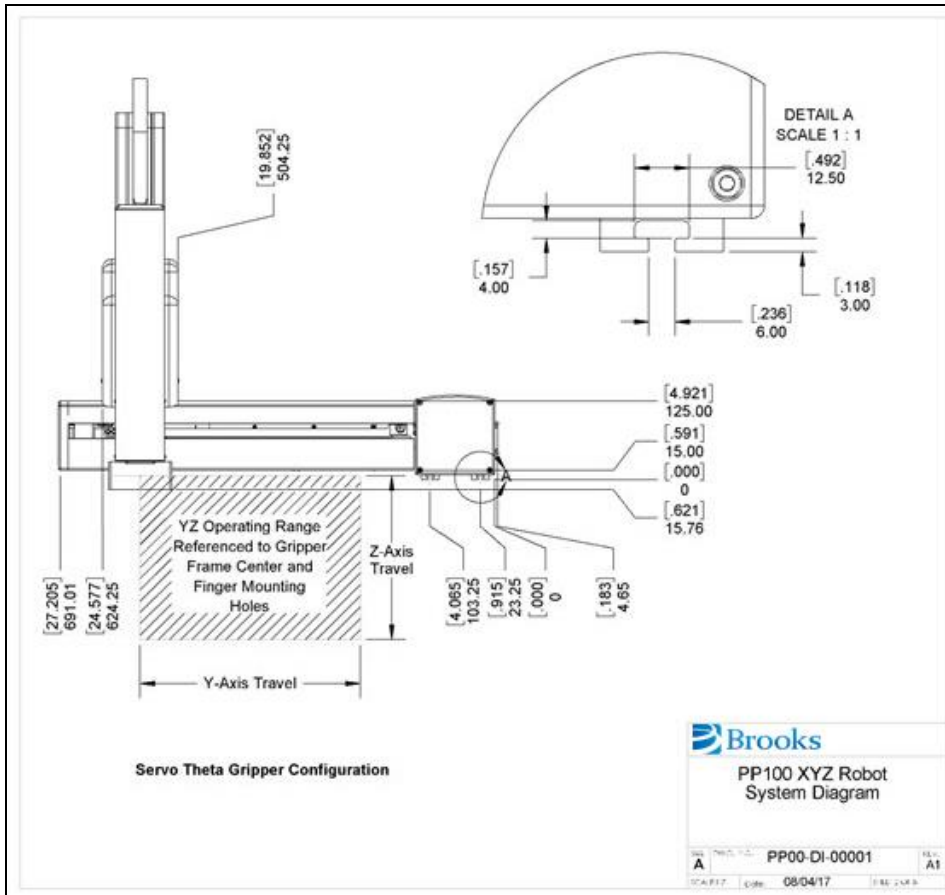

Figure 3-3: XYZ Robot with Gripper, Side View

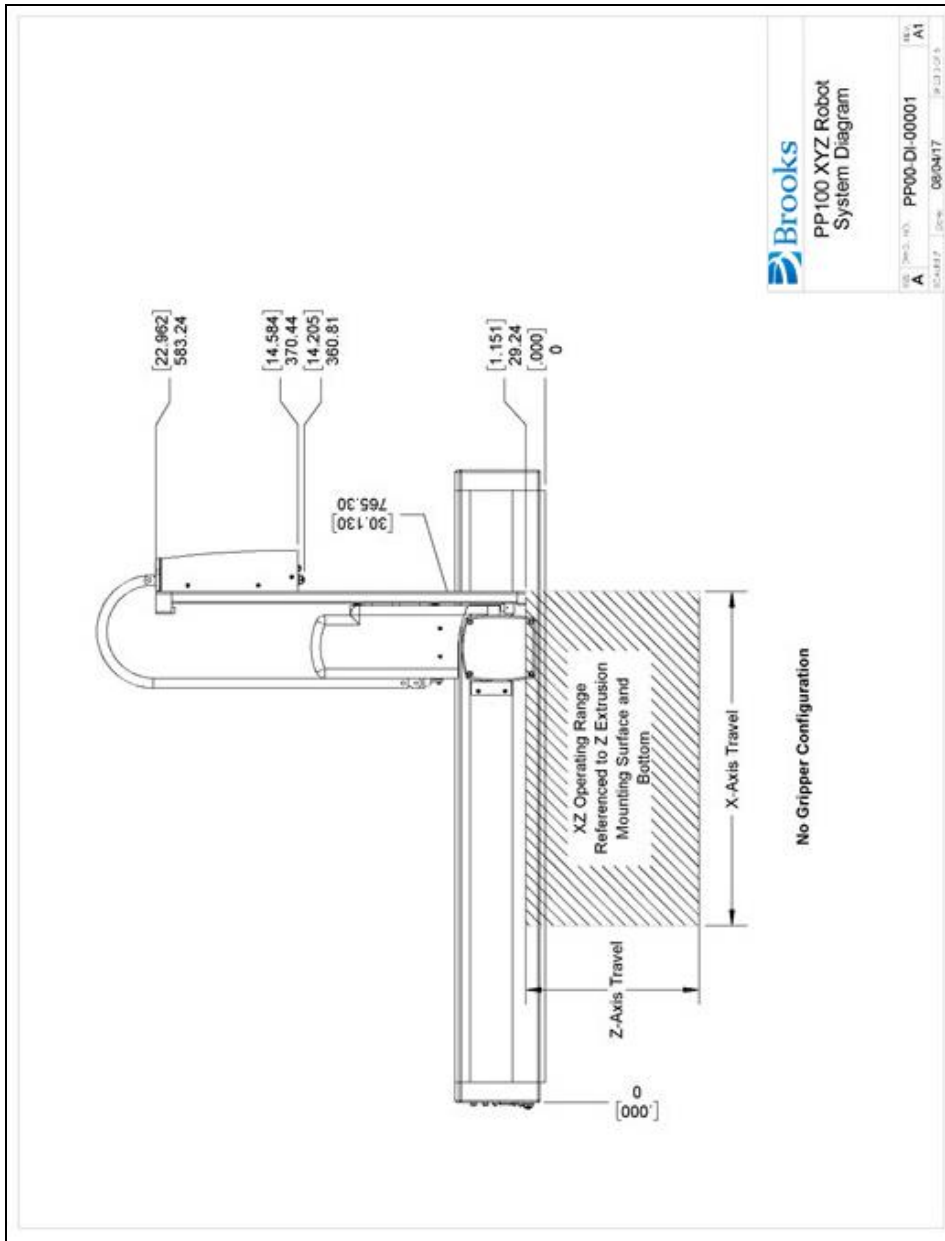

Figure 3-4: XYZ Robot without Gripper, Front View

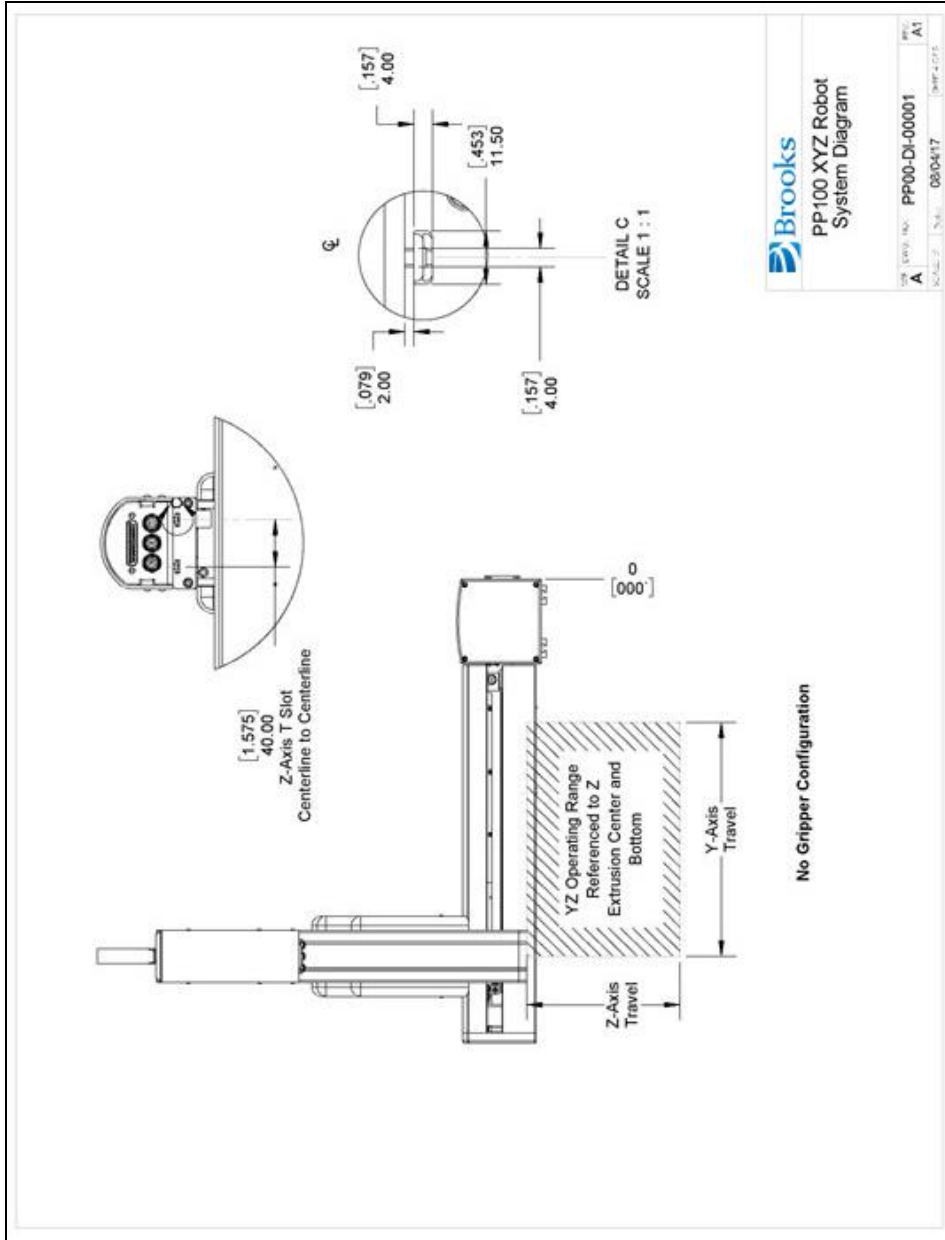

Figure 3-5: XYZ Robot without Gripper, Side View

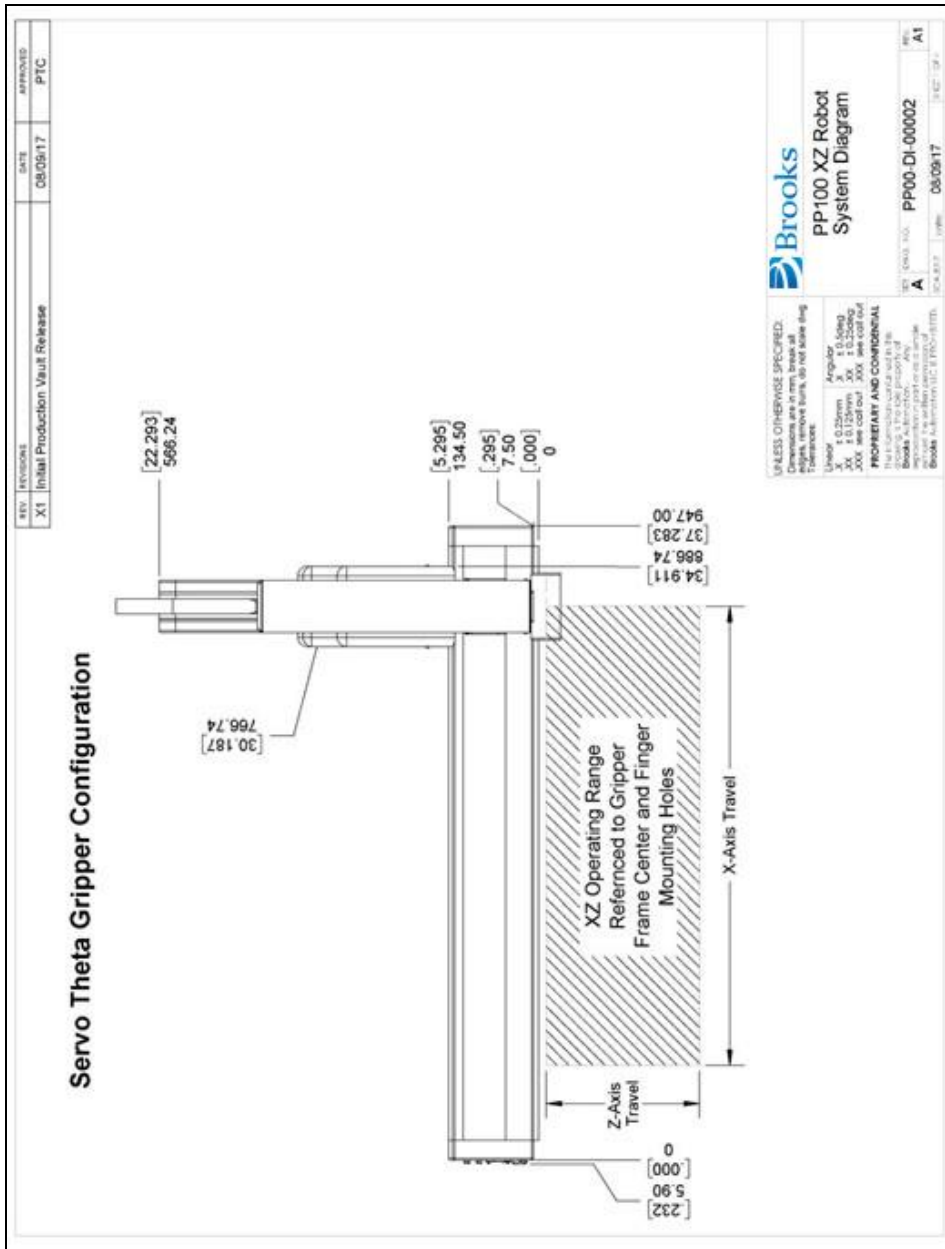

Figure 3-6: XZ Robot with Gripper Front View

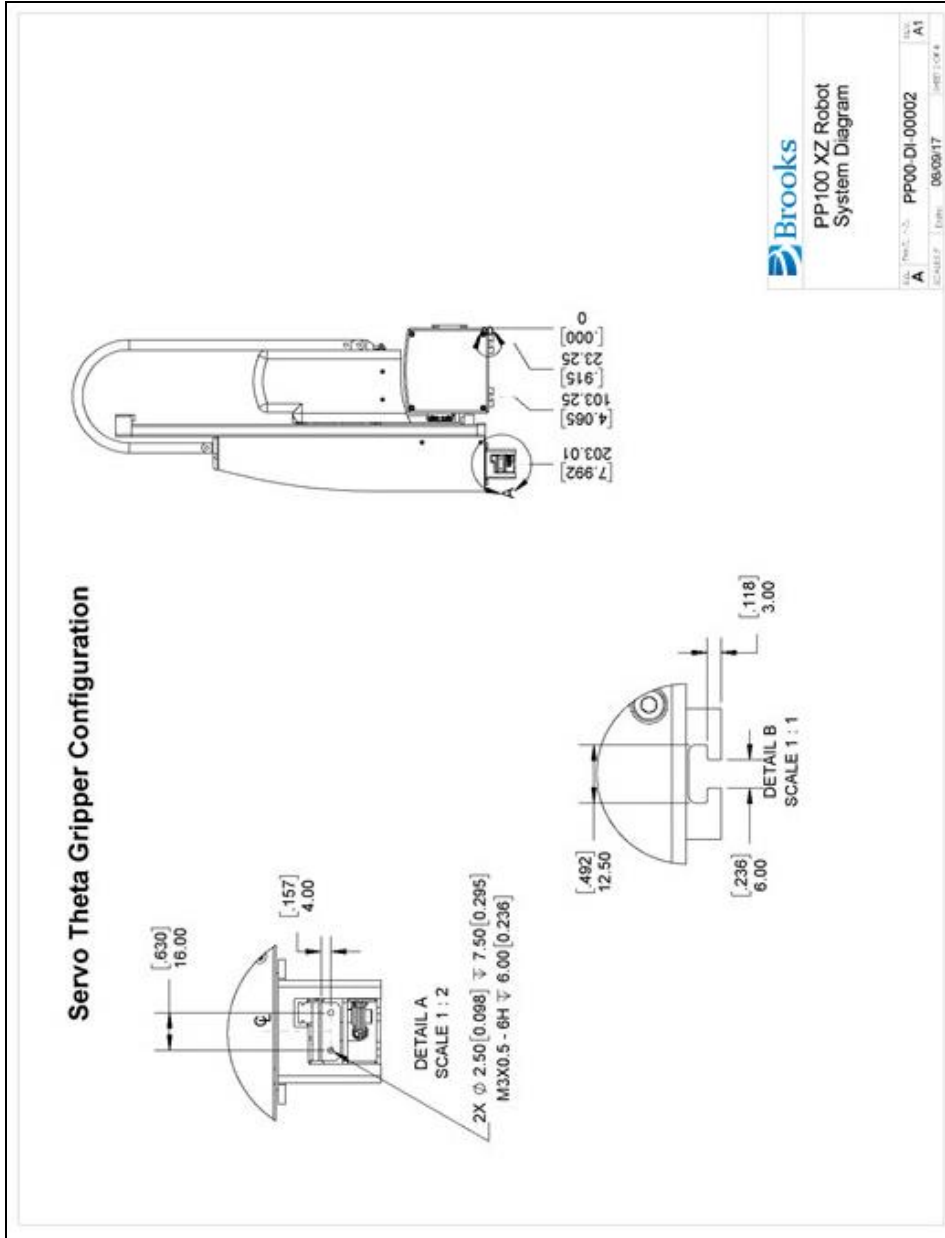

Figure 3-7: XZ Robot with Gripper, Side View

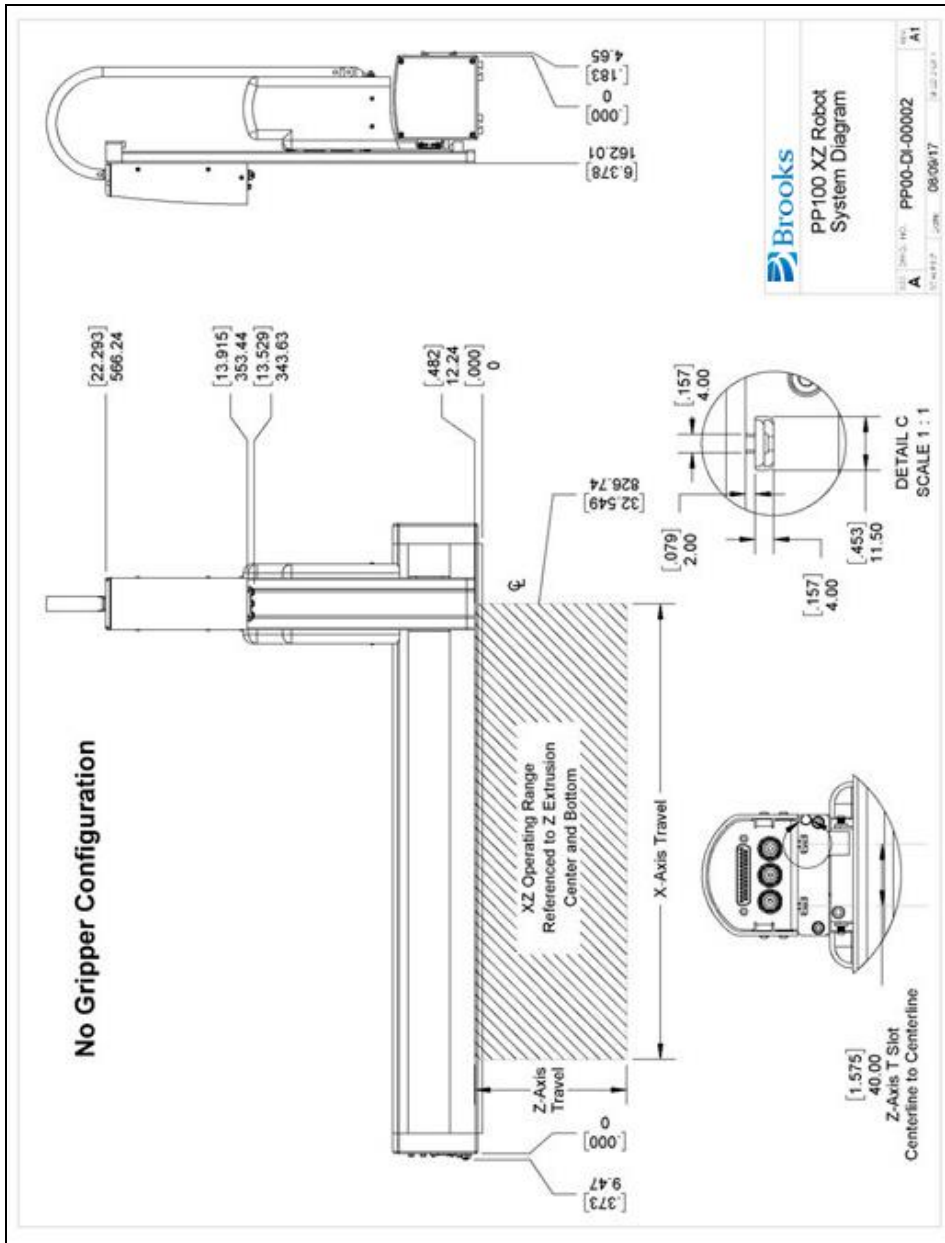

Figure 3-8: XZ Robot without Gripper

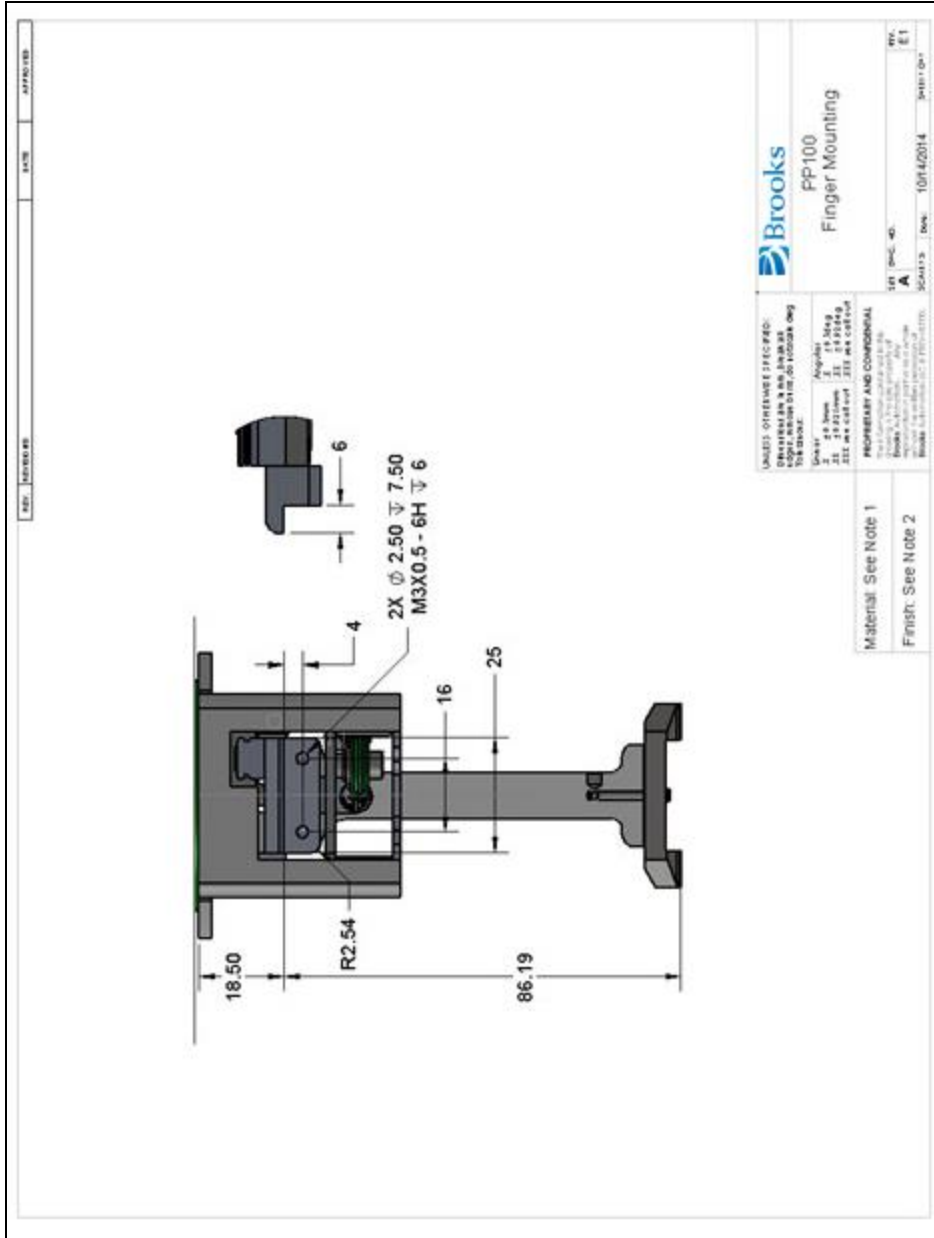

Figure 3-9: PP100 Finger Mounting

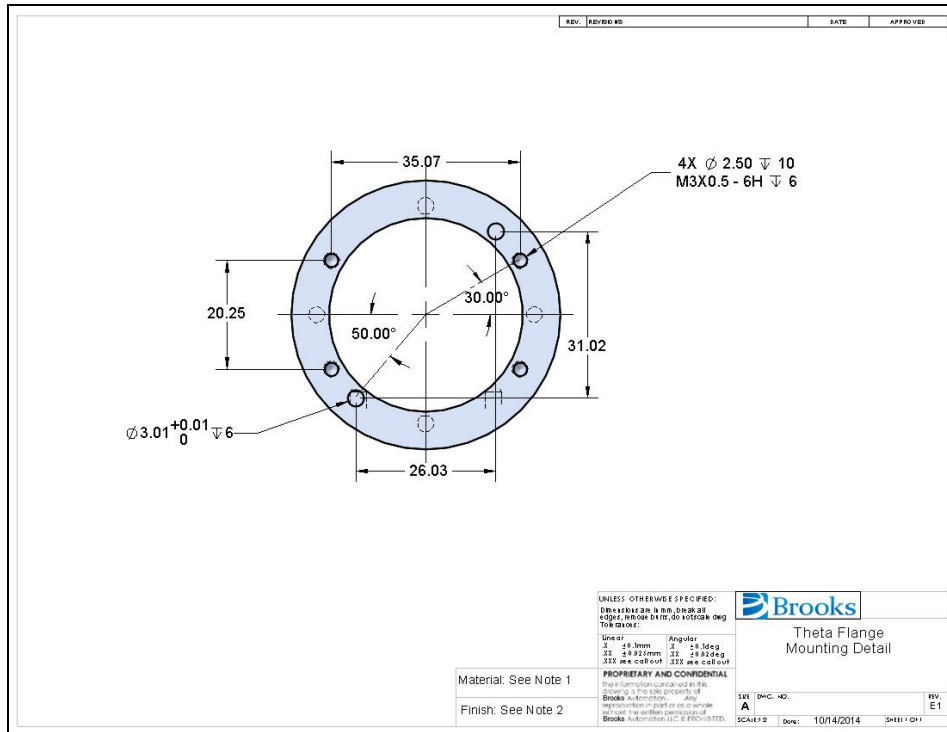

Figure 3-10: Theta Flange Mounting Detail

Unpacking and Handling Instructions

PreciseFlex™ robots are shipped in wooden crates with international ratings and foam inserts to protect the robots. As the robots weigh 25 kgs or more, two persons should move the robot to the installation location.

Mounting Instructions

PreciseFlex robots must be attached to a rigid surface that can withstand lateral forces of 200 Newtons without moving or vibrating. The robot X-axis has T-Slots to accommodate M4 Economy T-Nuts for mounting screws located as shown above. M4 Economy T-Nuts, PN NDM04022 are available from Buckeye Fasteners.

Tool Mounting

The PrecisePlace 100 is typically supplied with an electric gripper. In some cases, a pneumatic gripper or vacuum gripper may be supplied by Precise or by the end user. However, the standard robot does not include pneumatic lines, so if pneumatic tooling is needed, the robot must be ordered with pneumatic lines installed. There are fittings for two pneumatic lines in the end cap. If a Theta-axis is ordered, a pneumatic or vacuum gripper can be attached to the Theta flange.

To facilitate electrical interfacing to user tooling, digital I/O signals are available in the outer link. For robots with an electric gripper, the electric gripper controller in the outer link has two extra inputs and two extra outputs available for users. However, it should be noted that all the wires in the 10-conductor ribbon cable for the electric gripper are consumed by the electric gripper, so any additional IO wiring will have to be routed outside the robot wrist. For robots without the electric gripper, the robot can be ordered with the “GIO” option installed on the Z-axis. This option provides 12 5-24V inputs and 8 24V, 100ma outputs, and can be used for air solenoids and other functions. For robots where support for a pneumatic gripper or pneumatic tooling has been ordered, 2 1/8 in OD air hoses are routed from the connector plate in the base through the robot and out to the Z extrusion. These air hoses can be connected to a solenoid(s) mounted on the Z extrusion for tooling control.

Accessing the Robot Controller

Although most of the controller interface signals are exposed on the Facilities Panel at the base, there are times when it may be necessary to access either the robot's controller or its power supplies. To access the robot controller, the cover on the rear of the X-axis must be removed by removing the M3 flat head screws that attach the rear cover to the X-axis. See the *Guidance 1000A/B Controller, Hardware Introduction and Reference Manual* for detailed information on hardware configuration and interfacing the controller using the various input and output ports such as those for digital I/O. Also, refer to the *Guidance System Setup and Operation Quick Start Guide* for information on configuring the PC and instructions on operating the robot. Both of these manuals are available in PDF format and are also contained in the *PreciseFlex Library*.

Power Requirements

The robot's power supplies have an input range of 100 to 240 VAC, +/- 10%, 50/60 Hz. The robots are equipped with an IEC electrical socket that accepts country specific electrical cords. Power requirements vary with the robot duty cycle, but do not exceed 200 Watts RMS.

Emergency Stop

It is necessary to wire an Emergency Stop Button to the controller. This button may be wired in series with other emergency stop contacts. The E-stop signals are available in the Manual Control Pendant 9-pin DSub connector that is mounted on the left end cap of the X-axis. See [Hardware Reference](#) for detailed information on the E-Stop signals.

4. Hardware Reference

System Schematics, Diagram, and Power Supplies

The robot has a 24VDC and 48VDC power supply located in the X-axis. The robot controller and electric gripper are powered by the 24VDC supply. The four main robot motors are powered by the 48VDC supply. The 48VDC supply is protected against over voltage bus pump up by an energy dump function, which connects a 25 Watt dump resistor across the 48VDC supply output when the voltage reaches 56 Volts, and disconnects the dump resistor when the voltage drops to 52 Volts. This protects the power supply during high speed motor deceleration when the motor generates Back EMF voltage that adds to the power supply voltage.

The DC power is routed from the power supplies to the controller via an electrical harness.

Four digital input and four digital output signals along with 24VDC and Ground from the main robot controller are connected to a 15-pin Dsub connector on the connector end cap.

The ESTOP circuit is also connected from the controller to the 9-pin Dsub connector on the end cap. The ESTOP pins on this connector must have either a jumper or ESTOP switch installed that completes the ESTOP circuit or motor power cannot be enabled.

The gripper controller (GSB) is connected to the main controller through an RS485 cable that is routed through the robot. The RS485 cable also supplies 24VDC power for the gripper controller. The gripper motor has a single ended incremental encoder and therefore the gripper controller is configured for a single ended encoder and the GSB board has an "SE" label on it to indicate single ended.

The X motor and Y motor, if installed, plug into the G1400D controller in the back of the X extrusion. The Z motor and Theta motor signals are also connected to slave controllers (GSB) located on the Z-axis. However, the Z motor and Theta motors have absolute differential encoders and therefore the GSBs for both these motors have "Diff" label to indicate the controller is configured for a differential encoder.

NOTE: The "SE" and "Diff" GSBs are not Interchangeable.

The cable from the brake release button at the rear of the Z motor housing plugs into the GSB controller located near the Z motor. This button provides a ground return from the Z-axis brake to

ground bypassing the transistor that performs this function under computer power so that the brake can be released manually without motor power being enabled.

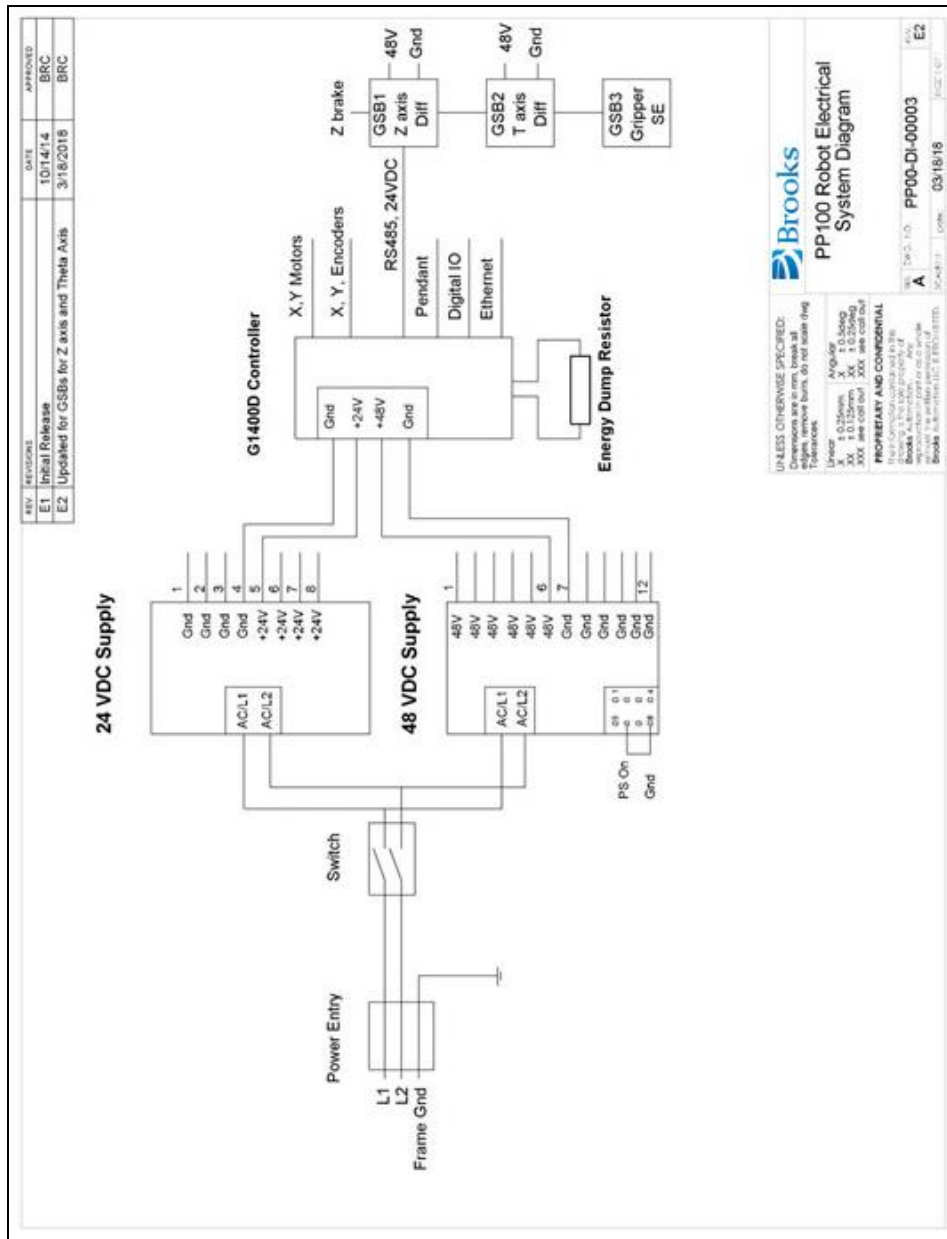

Figure 4-1: PP100 Robot Electrical System Diagram

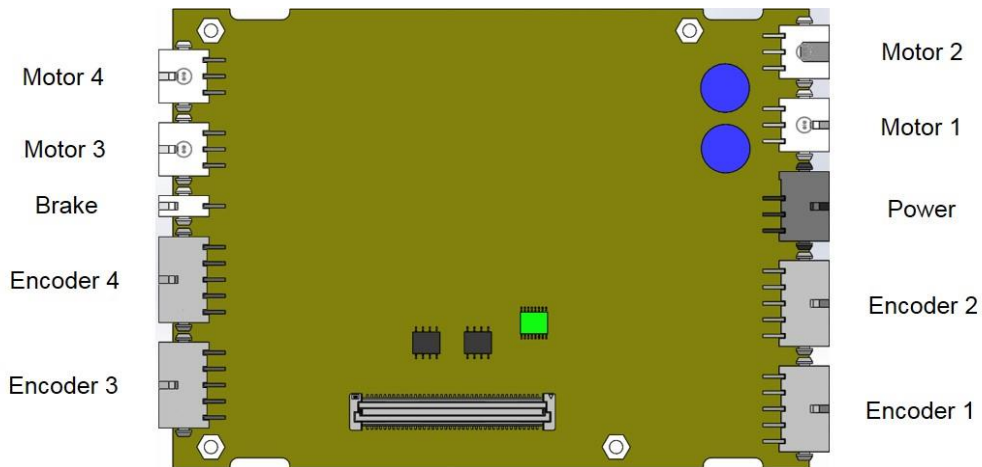

Figure 4-2: Controller Power Amplifier Connectors

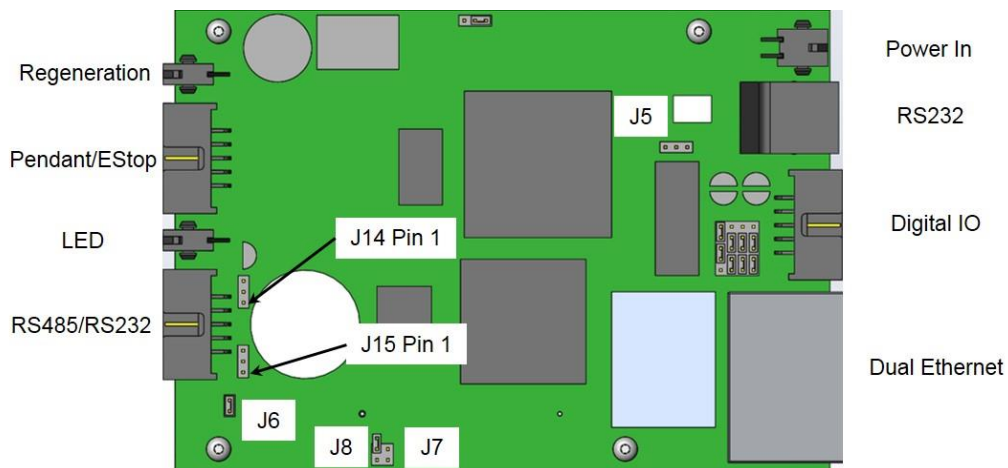

Figure 4-3: Control Board Connectors

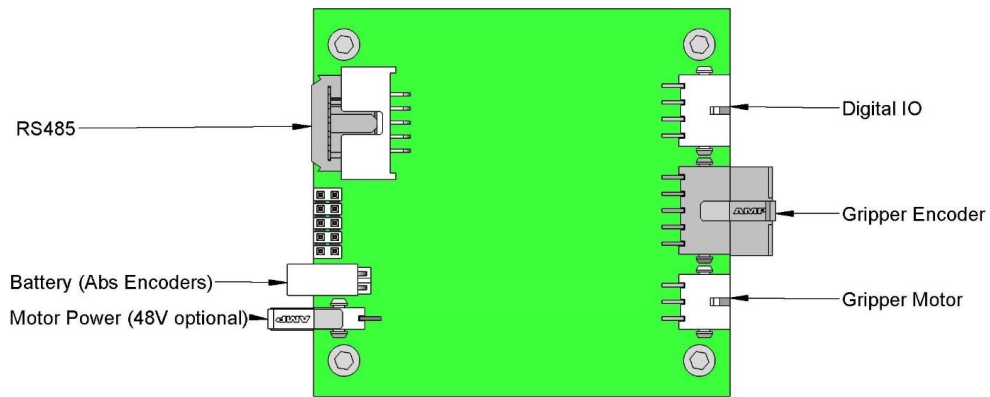

Figure 4-4: GSB Controller Connectors

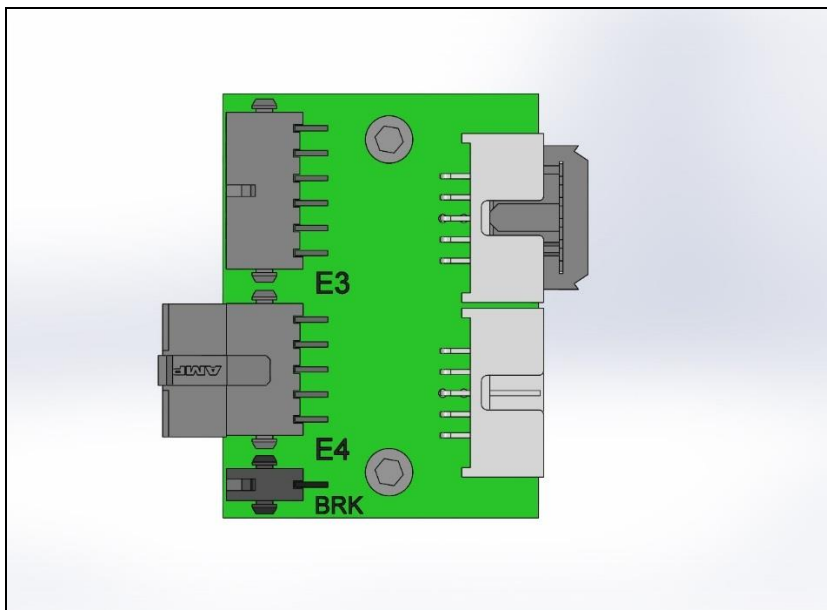

Figure 4-5: Encoder Patch Board (Discontinued when GSBs Added for Z and T axes)

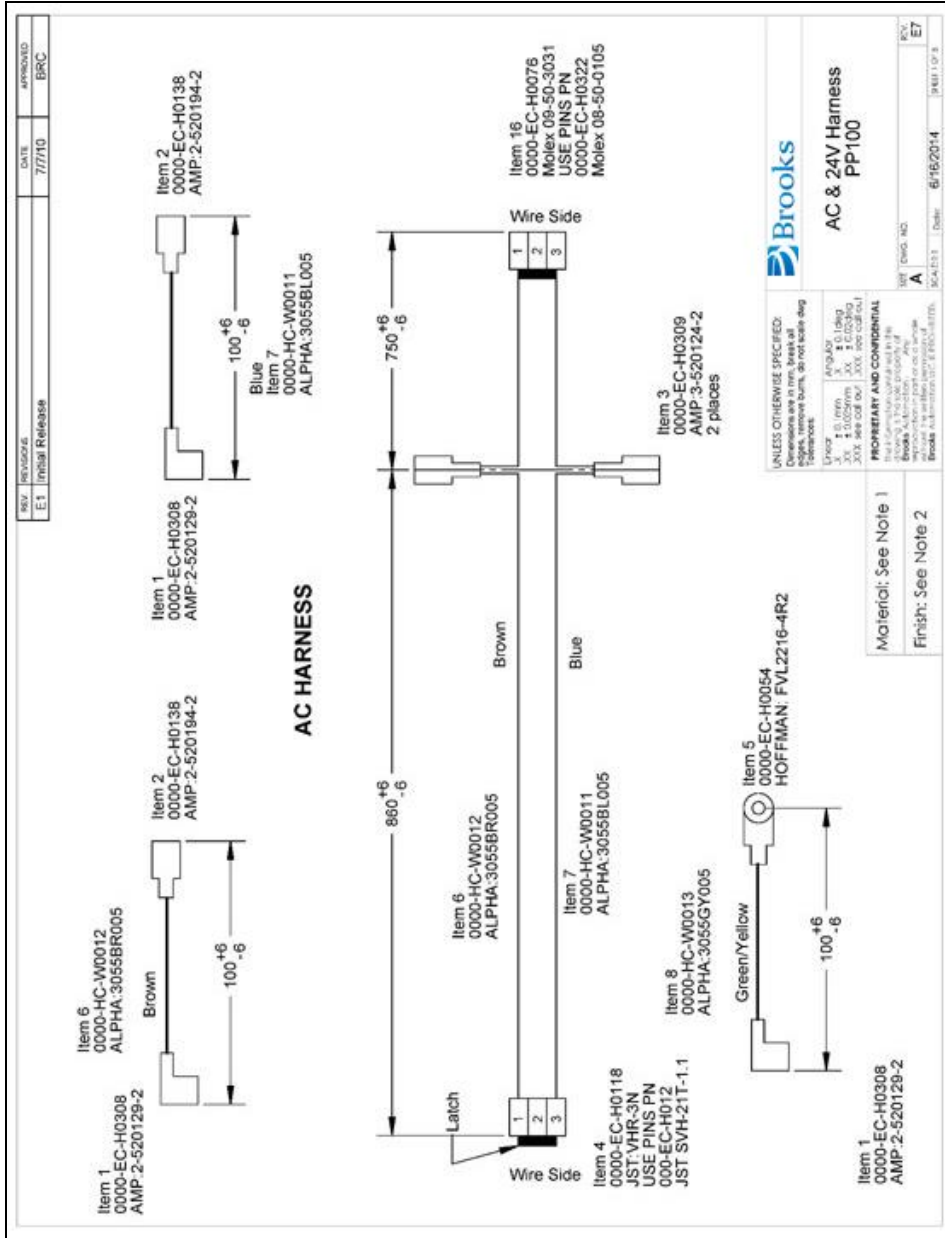

Figure 4-6: AC & 24 V Harness, PP100

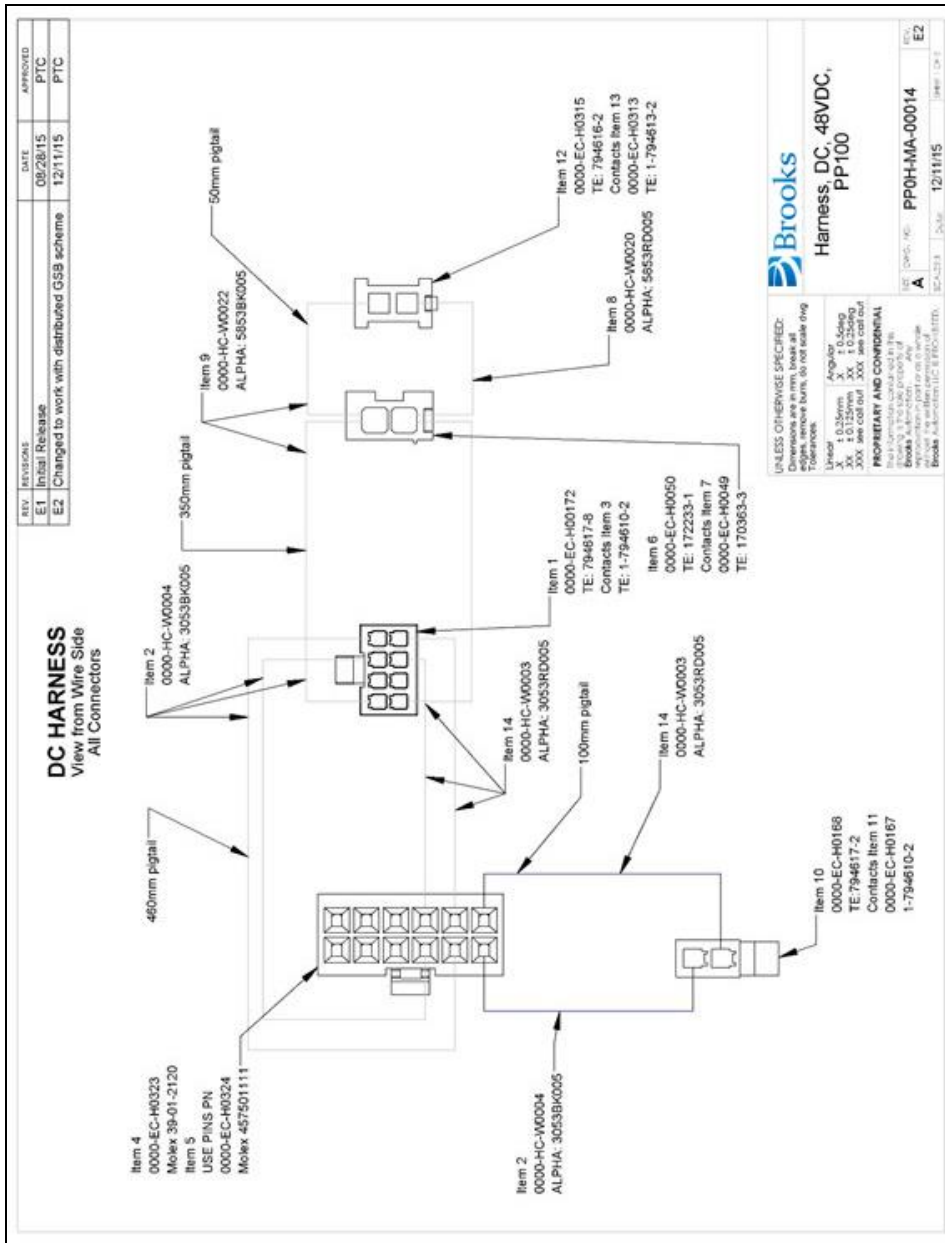

Figure 4-7: Harness, DC, 48VDC

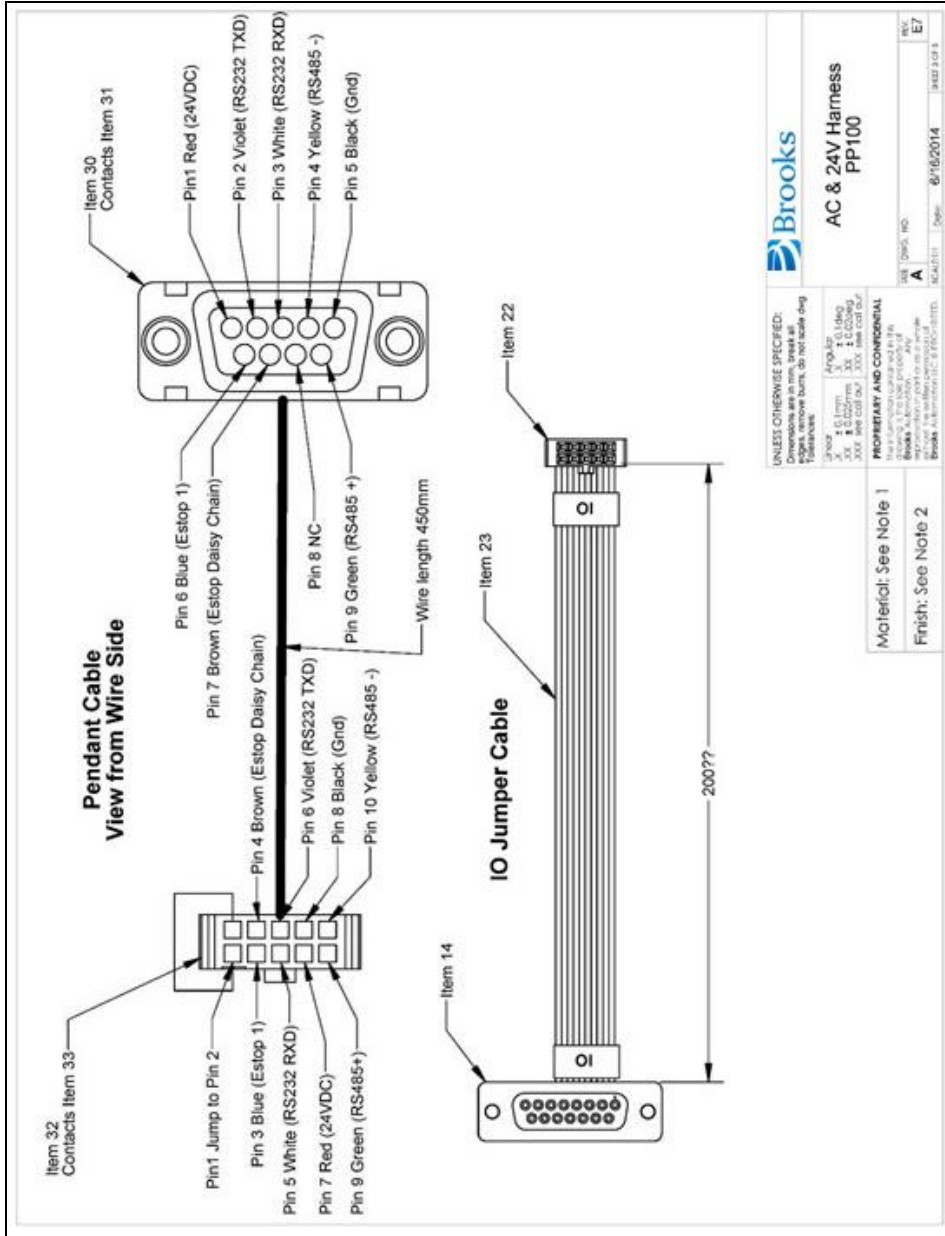

Figure 4-8: AC & 24V Harness

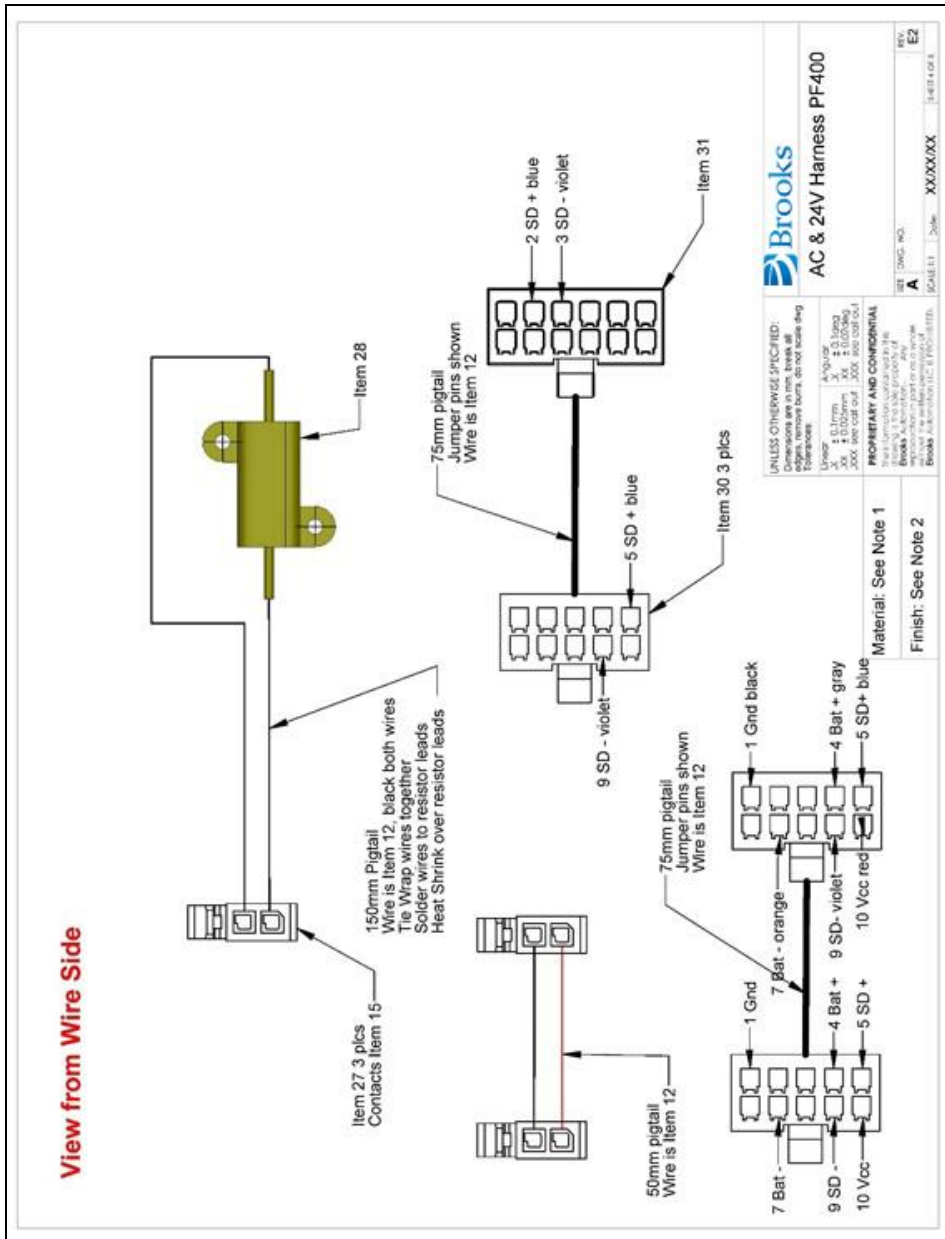

Figure 4-9: AC & 24V Harness PF400

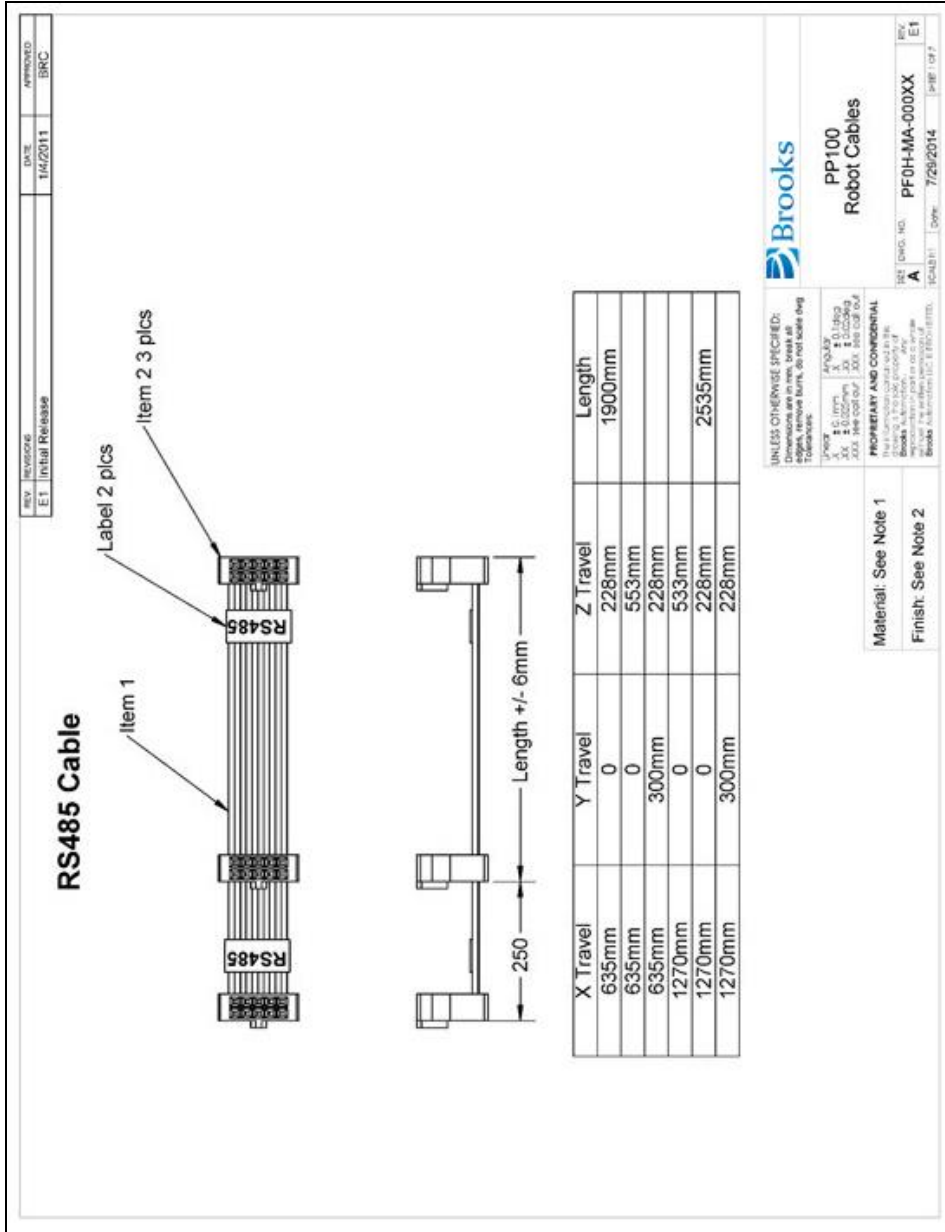

Figure 4-10: PP100 Robot Cables

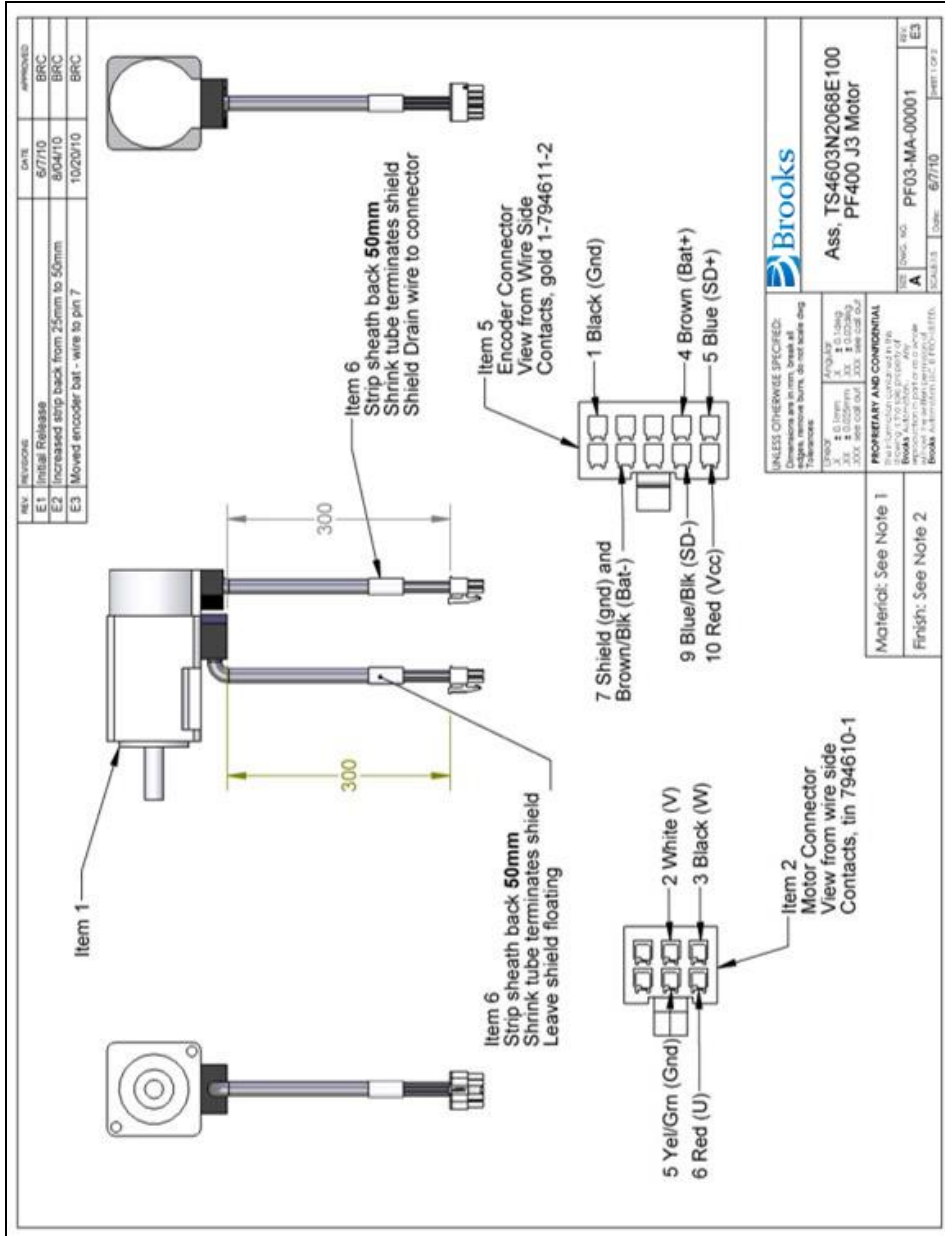



Figure 4-12: Theta Motor Assembly, X, Y, PF400 J3 Motor



Robot Inputs and Outputs

Robot Interfaces

Each of these interfaces is described in detail in the following sections. In addition, the robot's controller, which is mounted in the X-axis of the robot, may contain additional interfaces (e.g. inputs or outputs). Refer to the *Guidance 1000A/B Controllers, Hardware Introduction and Reference Manual* for additional information.

 DANGER Electrical Shock	
<p>The Guidance 1400A controller and the 24VDC and 48VDC power supplies are all open frame electrical devices that contain unshielded high voltage pins, components and surfaces. Working with energized equipment may cause electrical shock and may result in serious injury or death.</p> <ul style="list-style-type: none">• Disconnect the main AC power before removing the Facilities Panel.	

If the pneumatic gripper option is ordered one air line is routed through the interior of the robot. At the connector end cap, this air line is presented in a fitting mounted to the connector end cap. The other end of this line exits at the Z Extrusion. When using this line, clean, dry external air should be provided.

 CAUTION	
<p>The maximum air pressure that can be conveyed by the air lines through the robot is 75 PSI. Applying a pressure exceeding this level may disconnect interior connections or damage fittings or hoses.</p> <ul style="list-style-type: none">• If a higher pressure is required, utilize an external air line should be utilized.	

MCP/E-Stop Interface

The MCP interface includes the signals necessary to connect a Manual Control Pendant, an E-Stop circuit, or an external RS485 Remote IO Module. These signals are provided in a DB9 female connector (see [Figure 4-14](#) and [Table 4-1](#)) mounted on the X-axis end cap.

In order for the robot to allow motor power to be enabled, the E-Stop circuit must connect 24VDC to E-Stop1 in this connector. If no E-Stop box or circuit is connected, then the circuit must be completed with jumper plugs. (The robot is shipped with a Dsub jumper plug that satisfies this requirement.)

If a Manual Control Pendant is not connected to the secondary RS-232 port provided in this connector, this serial interface can be accessed via a GPL procedure as device `"/dev/com2"` for general communications purposes.

NOTE: Unlike the primary serial interface, this secondary serial interface does not support flow control.

The RS485 port is used internally to communicate with the gripper controller and is also be used for the Remote IO option. As such it has a dedicated protocol and is not available for general use.

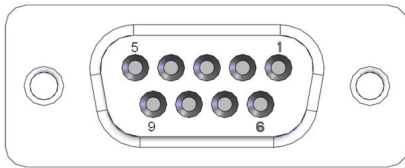

Figure 4-14: DB9 Female Connector

Table 4-1: Pinout

Pin	Description
1	24VDC
2	RS232 TXD
3	RS232 RXD
4	RS485-
5	Gnd
6	E-Stop1
7	E-Stop Daisy Chain
8	48VDC
9	RS485+
Interface Panel Connector Part No	DB9 Female Connector AMP 5747150-7

Pin	Description
User Plug Part No	DB9 Male Plug Amp 1658655-1 (crimp) Pins 22-26AWG 745254-6

Digital Input Signals

The standard PreciseFlex 100 robot provides four general purpose optically isolated digital input and output signals at the X-axis end cap (in addition to those signals that are available at the Gripper Control Board).

The input signals can be configured as "sinking" (Figure 4-15 and Figure 4-17) or "sourcing" (Figure 4-16 and Figure 4-18). If an input signal is configured as "sinking," the external equipment must pull its input high to 5VDC to 24VDC to indicate a logical high value or must allow it to float to no voltage for a logical low. These four inputs are configured at the factory as "sinking."

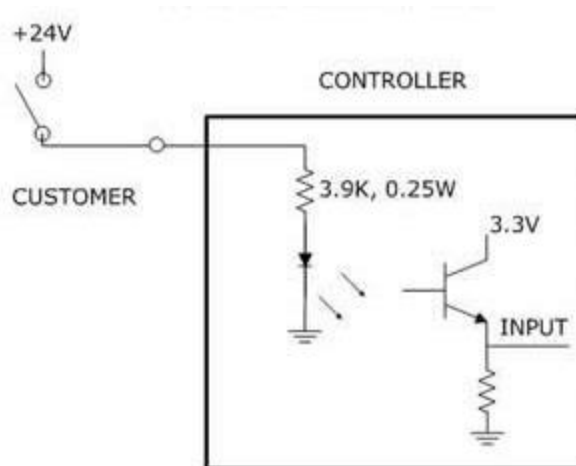

Figure 4-15: Sinking Digital Input

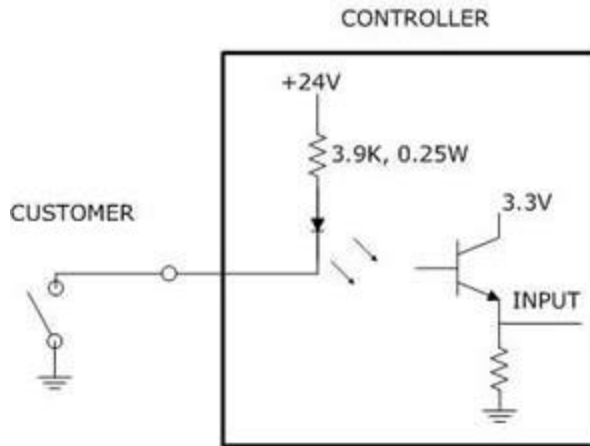

Figure 4-16: Sourcing Digital Input

By setting Jumpers on the CPU (MIDS4) board, the four output signals can be individually configured as "sinking" or "sourcing" and the four digital inputs can be configured as a group to all operate as either sinking or sourcing. For more information on configuring the jumpers, see the *Guidance 1000A/B Controllers, Hardware Introduction and Reference Manual*.

Digital Output Signals

The robot provides four general-purpose optically isolated digital output signals at the G1400A controller.

These output signals can be configured as "sinking" or "sourcing." As shipped from the factory, output signals 1-3 are configured as "sourcing," i.e. these outputs provide 24VDC when turned on. Output 4 is configured as "sinking" i.e. the external equipment must provide a 5VDC to 24VDC pull up voltage on an output pin and the controller pulls this pin to ground when the signal is asserted as true.

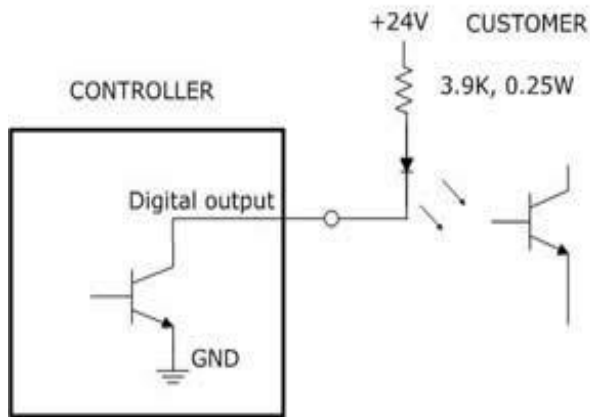

Figure 4-17: Sinking Digital Output

Alternately, the output signals can be configured as "sourcing," i.e. the external equipment must pull down an output pin to ground and the controller pulls this pin to 24VDC when the signal is asserted as true.

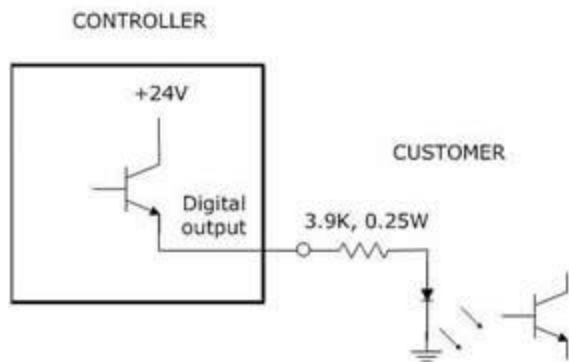

Figure 4-18: Sourcing Digital Output

Outputs can be individually configured as sinking or sourcing signals. For more information on configuring the jumpers, see the *Guidance Controller, Hardware Introduction and Reference Manual*.

The pinout for the fifteen Pin Dsub Digital Input and Output Connector ([Figure 4-19](#)) and the corresponding GPL signal numbers are described in [Table 4-2](#).

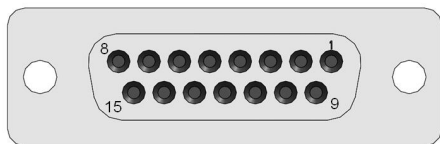

Figure 4-19: Fifteen Pin Dsub Digital Input and Output Connector

Table 4-2: GPL Signal Numbers

Pin	GPL Signal Number	Description
1	13	Digital Output 1
2	15	Digital Output 3
3		GMD
4	10001	Digital Input 1
5	10003	Digital Input 3
9	14	Digital Output 2
10	16	Digital Output 4
11		24VDC
12	10002	Digital Input 2
13	10004	Digital Input 4
User Plug Part No		TE 1-747946-5 15-pin plug with backshell or DB9 Male Plug Amp TE 1658657-1 (crimp) Pins 22-26AWG TE 745254-6

Gripper Controller Digital Inputs and Outputs

If the robot is equipped with an electric gripper, the gripper controller includes three sinking digital inputs and three sourcing digital outputs. One digital input and one digital output are dedicated for a lighted teach button on some electric grippers. The other two inputs and outputs are available in the outer link for application use. See [Table 4-3](#).

Table 4-3: Pinout & GPL Signal Number

Pin	GPL Signal Number	Description
1	200013	Digital Output 1/LED driver
2	200014	Digital Output 2
3	200015	Digital Output 3
4		24VDC output

Pin	GPL Signal Number	Description
5		GND
6	210001	Digital Input 1
7	210002	Digital Input 2
8	210003	Digital Input 3
User Plug Part No		Amp 794617-8, crimp contacts 1-794611-2

RS485 Remote IO Module (GIO)

Customers who need additional digital IO may order the RS485 Remote IO Module. This module installs in the X-axis of the robot and provides 12 Digital Inputs and 8 Digital Outputs in a 25-pin Dsub connector.

The RS485 Remote IO Module (GIO) provides 12 general-purpose optically isolated digital input signals and 8 general-purpose optically isolated digital output signals. Two inputs, 11 and 12, can be optionally configured as analog inputs by means of jumpers J1 and J2. Connecting J1 to pins 1 and 2 (default) configures these inputs as digital and connecting pins 2 and 3 configures them as analog. These input and output signals are intended for interfacing to tooling and sensors or for general application needs. This board is connected to the controller by an RS485 serial line that allows the controller to scan the GIO I/O with a nominal period of 4 milliseconds.

The DIO signals are accessible via the DB25 female connector ([Figure 4-20](#) and [Table 4-4](#)) mounted on the facilities panel when this option is ordered. The DIO signals addresses are determined by a base address set by a DIP switch on the DIO board. For the PF400 robot without the linear axis option the DIO option is located at the robot connector panel and for both this location and also for the location at the end of the optional linear axis, all the address jumpers will NOT be installed, which sets the address of this module to “8.” This address avoids conflicts with other RS485 network controllers for the gripper and optional linear axis. See [“Installing the Optional GIO Board”](#) under [Service Procedures](#) for details on installing this module.

The software addresses will then be as follows.

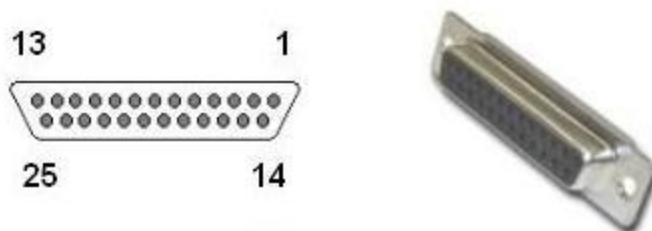

Figure 4-20: DB25 Female

Table 4-4: Pinout & GPL Signal Number

Pin	GPL Signal Number	Description
1		Gnd
2	810001	Digital Input 1
3	810003	Digital Input 3
4	810005	Digital Input 5
5	810007	Digital Input 7
6	810009	Digital Input 9
7	810011	Digital Input 11
8		24VDC
9	800013	Digital Output 1
10	800015	Digital Output 3
11	800017	Digital Output 5
12	800019	Digital Output 7
13		24VDC
14		Gnd
15	810002	Digital Input 2
16	810004	Digital Input 4
17	810006	Digital Input 6
18	810008	Digital Input 8
19	810010	Digital Input 10
20	810012	Digital Input 12
21		24VDC
22	800014	Digital Output 2
23	800016	Digital Output 4
24	800018	Digital Output 6
25	800020	Digital Output 8
Interface Panel Connector Part No		DB25 Female Connector
User Plug Part No		DB25 Male Plug

Ethernet Interface

PreciseFlex robots include an Ethernet switch that implements two 10/100 Mbit Ethernet ports. This capability was designed to permit the controller to be interfaced to multiple Ethernet devices such as other PreciseFlex™ controllers or robots, remote I/O units and Ethernet cameras. The Ethernet switch automatically detects the sense of each connection, so either straight-thru or cross-over cables can be used to connect the controller to any other Ethernet device.

Due to limited space on the Facilities Panel, only one of the two Ethernet ports is available via an external RJ45 connector. This external Ethernet port is typically used to interface the robot to a PC. The second Ethernet port is only available inside the X-axis of the robot. In some cases, it may be used to connect an Ethernet camera that is mounted on the robot or a vision processing unit mounted inside the X-axis.

In this case, a PC that is connected to the Ethernet plug on the Facilities Panel can communicate with the robot's controller as well as receive images from an arm-mounted camera. If a camera is mounted in the workcell, an external Ethernet switch must be added to connect these cameras and the robot to a PC.

See the *Setup and Operation Quick Start Guide* for instructions on setting the IP address for the controller.

RS-232 Serial Interface

The robot includes a standard RS-232 serial line equipped with hardware or software flow control. However, this port is only available on the G1400A controller in the X-axis of the robot and is not brought out to any outside connector on this robot. If needed, a DB9 connector can be added by the user to the rear sheet metal panel of the X-axis and a RJ-11 to DB9 pigtail can be added to access this port. This port can be used to communicate to the system serial console or can be connected to external equipment for general communication purposes. When used for general communications, this port is referenced as device `"/dev/com1"` within the Guidance Programming Language (GPL).

The connector for this interface is a standard RJ11 serial interface connector that has pin assignments compatible with standard PC "com" ports. For this robot it is only used for debugging and special service procedures.

5. Software Reference

Accessing the Web Server

Many OEM customers run the PF400 using a PC to provide an application-specific operator interface. In order to update software in the controller, and view certain error messages, it is necessary to access the Web Server Interface embedded in the controller.

The Web Server Interface may be addressed by opening a browser (such as Internet Explorer) in a PC that is connected to the robot via Ethernet. Customers must know the IP address of the robot controller. Two common IP addresses are 192.168.0.1 and 192.168.0.10. The PC LAN interface address must be configured correctly (for example 192.168.0.100, with subnet mask 255.255.255.0). The Web Server Interface in [Figure 5-1](#) will display.

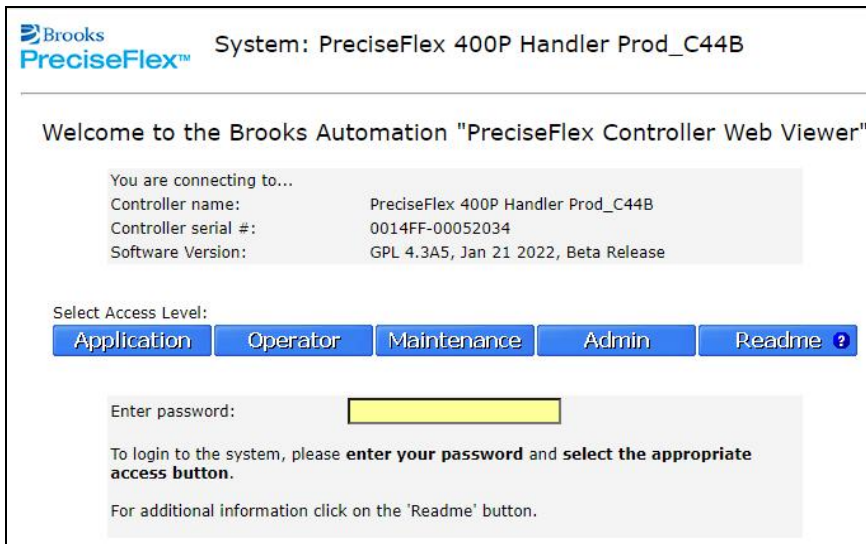

The screenshot shows the web interface for a Brooks Automation PreciseFlex controller. At the top left is the Brooks PreciseFlex logo. To its right, the system name is displayed: "System: PreciseFlex 400P Handler Prod_C44B". Below this is a welcome message: "Welcome to the Brooks Automation 'PreciseFlex Controller Web Viewer'". A section titled "You are connecting to..." provides system details: Controller name: PreciseFlex 400P Handler Prod_C44B, Controller serial #: 0014FF-00052034, and Software Version: GPL 4.3A5, Jan 21 2022, Beta Release. Under "Select Access Level:", there are five buttons: "Application", "Operator", "Maintenance", "Admin", and "Readme ?". Below the buttons is a password field labeled "Enter password:" with a yellow highlight. A message below the field reads: "To login to the system, please enter your password and select the appropriate access button." and "For additional information click on the 'Readme' button."

Figure 5-1: Web Server Interface

It may be necessary to enter a password if a company has protected access to the Web Interface. Once the password has been entered, click **Admin** to access all the features to perform system upgrades. The window in [Figure 5-2](#) will display.

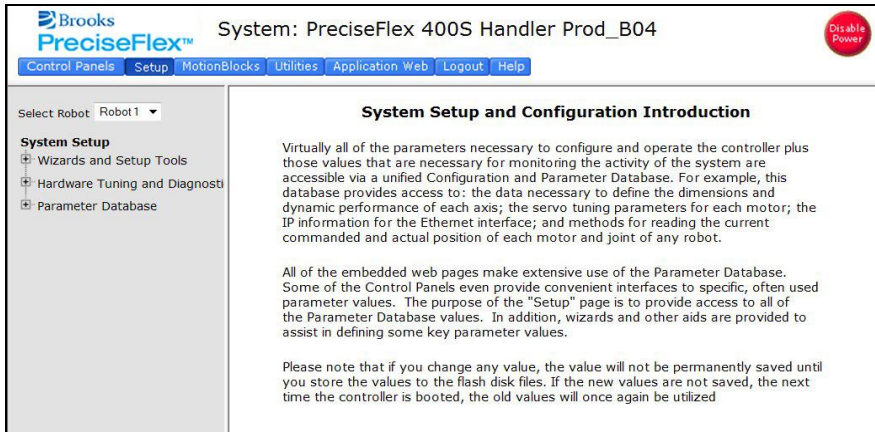

Figure 5-2: System Setup

Click **Control Panels**→**Operator Control Panel**. The window in Figure 5-3 will display.

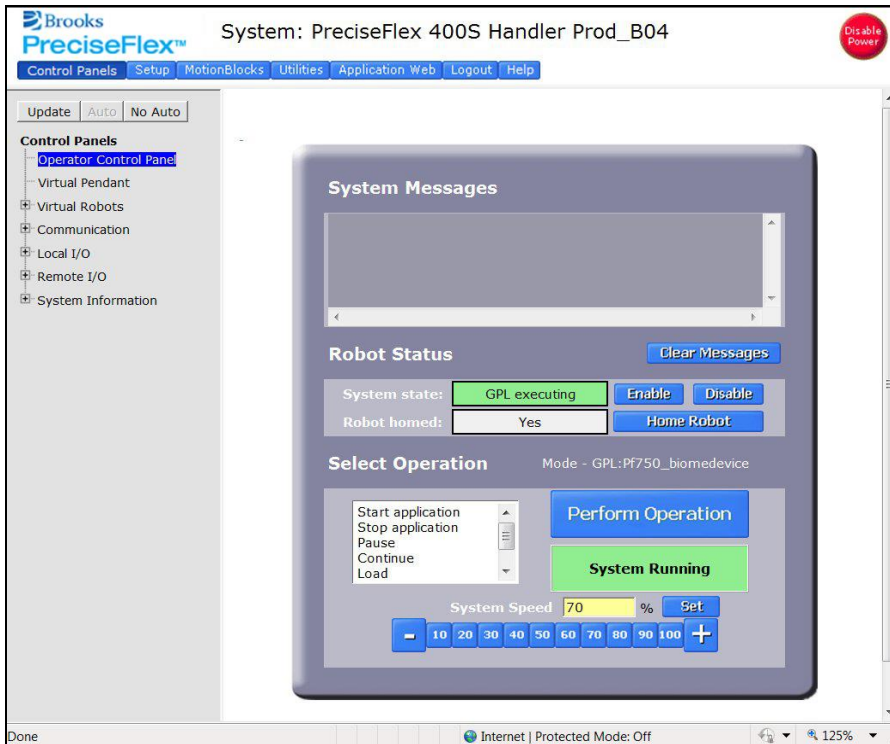
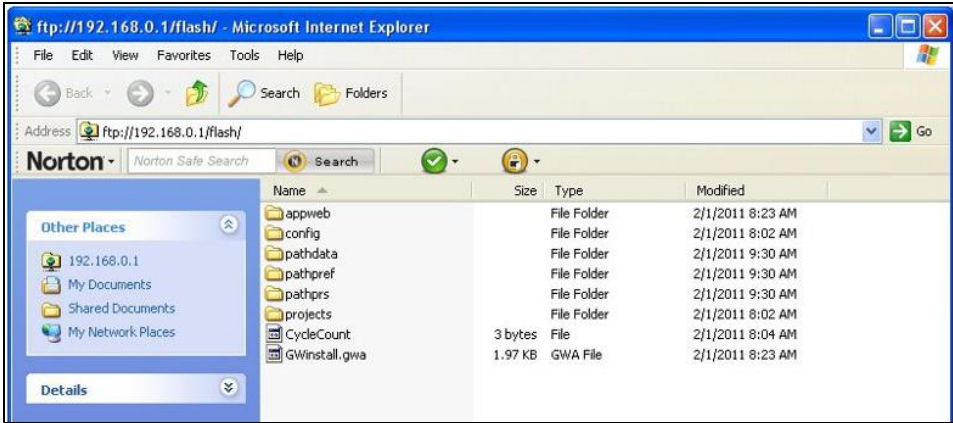

Figure 5-3: Operator Control Panel

If an application is running, the *System Running* panel will display in green. In order to run diagnostics, stop the application from running. Click **Stop Application**→**Perform Operation**. This will stop the application from running. Click the **Disable Power** button to be sure motor power is off. To load a new project (for example CAL_PP), click **Unload**→**Perform Operation** before loading the new project into RAM.

Loading a Project (Program) or Updating PAC Files

If CAL_PP or a different program needs to be loaded into the controller from an external computer, this may be done using the Web Interface.

Step	Action
1.	In the Web Based Operator Interface, select Utilities/Backup and Restore .
2.	<p>Click Start File Manager. It may be necessary to hold down the Control key to allow the pop-up screen. An ftp directory screen will display. In the Page menu in Windows Internet Explorer, select Open ftp site in Windows Explorer. Another screen will display showing several folders, including Config and Projects.</p> 
3.	To load a Project, open the Projects folder and paste the Project folder into this area. There may be several other projects (programs) loaded into this folder, which is stored in flash ram in the controller. A project folder is a software folder than may have several files inside it. Load the entire folder, not just the files inside.
4.	To load or update PAC files, open the Config folder and paste a backup copy of the PAC files into the Config folder. These files will all have a .pac extension. The robot must be re-booted after new PAC files are installed for them to take effect.
5.	Once the appropriate project (for example CAL_PP) has been loaded into flash memory, it must then be loaded into dynamic memory in order to execute. See the section below on Calibrating the Robot: Setting the Encoder Zero Positions for an example on how to load and execute the CAL_PP program.

Updating GPL (System Software) or FPGA (Firmware)

Both GPL (the system software) and the FPGA firmware may be upgraded in the field. To perform an upgrade, follow this procedure:

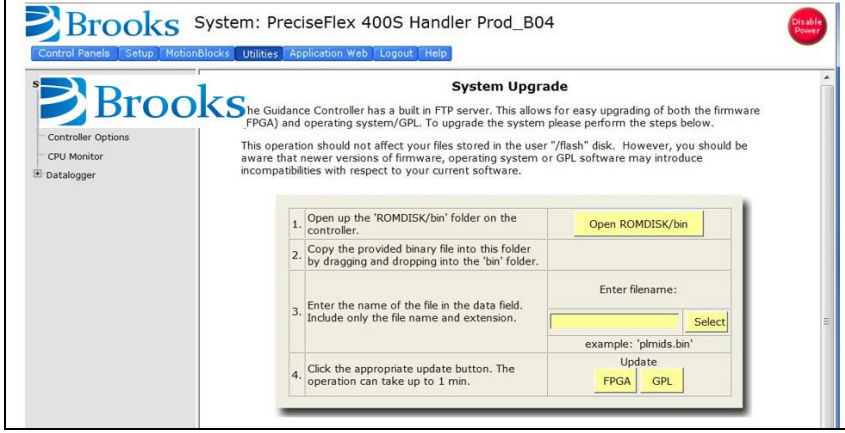
Step	Action
1.	Get the appropriate upgrade software from Brooks in the form of a .bin file. Email support_preciseflex@brooksautomation.com .
2.	<p>In the Operator Interface, go to the Utilities/System Upgrade menu.</p> 
3.	Click Open ROMDISK/bin . This will open an FTP window. Select Page in the browser, scroll to the bottom of the page menu, and click Open site in Windows Explorer . This will open a second ftp window in Windows. Paste the appropriate GPL or FPGA .bin file into this window.
4.	Under item 3 in the System Upgrade menu, click Select . A pick list will open up. Highlight the upgrade code in this pick list and click Select again. The name of the file will appear in the Filename field.
5.	In the menu, click on either FPGA or GPL to upgrade the appropriate file. The banner in the Upgrade menu will start flashing for about 10 seconds while the flash RAM is being written with the new file. Wait about 10 additional seconds after this banner stops flashing, then reboot the robot, and the new code will be installed.

Recovering from Corrupted PAC Files



PAC files are configuration files that determine the configuration of the robot for the software, including the robot factory calibration data. These files are stored in Flash RAM. Flash RAM is also used to store robot programs. The Flash RAM requires some time for a complete write cycle. During the write cycle, the console will display a flashing warning not to turn off robot power. If robot power is turned off during the Flash RAM write cycle, the Flash data may be lost or corrupted. If this happens, it is necessary to reload both the robot PAC files and any user programs that were stored in Flash RAM. This problem should typically not be encountered by a user unless the user is changing configuration files in the robot.

Brooks maintains a record of PAC files shipped with each robot Serial Number. If the PAC files have been corrupted, it is possible to get a backup copy from Brooks. The backup copy will contain the factory configuration and calibration data, but will not contain any changes, including any new calibration data, made after the robot has left the factory.

In order to allow the controller to recover from corrupted PAC files, a set of recovery boot up PAC files is loaded in the system area of the Flash.

To configure the controller to boot up in recovery mode the user must perform the following procedure:

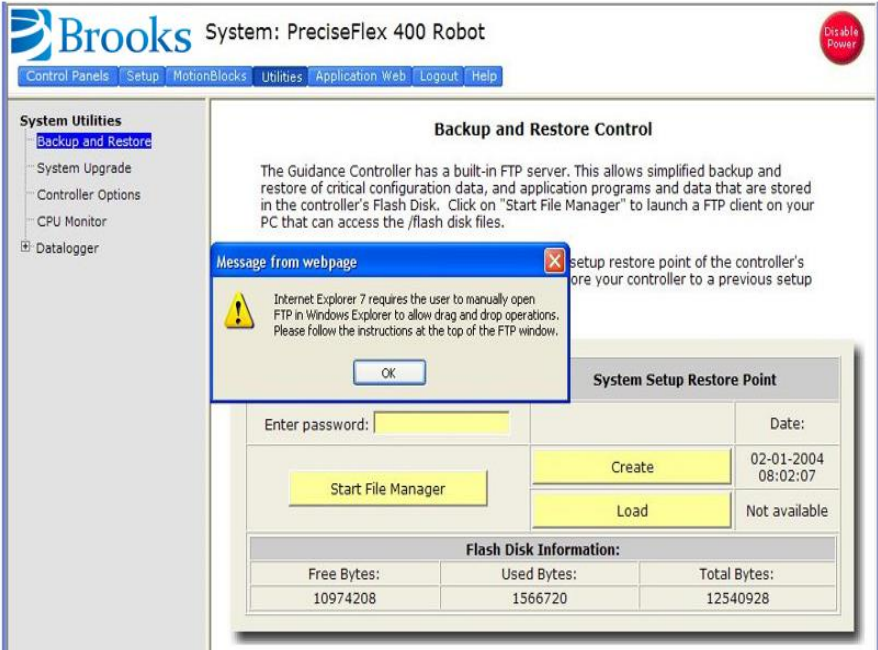
Step	Action
1.	Obtain a set of backup PAC Files from Brooks or local backup. Email support@preciseflex@brooksautomation.com .
2.	Disconnect power from the robot and remove the X-axis Cover of the robot.
3.	<p>Move Jumper J8 so that it connects the two jumper posts. This will cause the factory default configuration files to be loaded at controller boot up.</p> 
4.	Cycle robot power to reboot the controller.

Step	Action
<p>5.</p>	<p>In the Web Based Operator Interface, select System Utilities→Backup and Restore.</p> 
<p>6.</p>	<p>Click Start File Manager. It may be necessary to hold down the Control key to allow the pop-up screen to display. An ftp directory screen will display. In the Page menu in Windows Internet Explorer, select Open ftp site in Windows Explorer. Another window will open showing several folders, including “Config” and “Projects.”</p> 

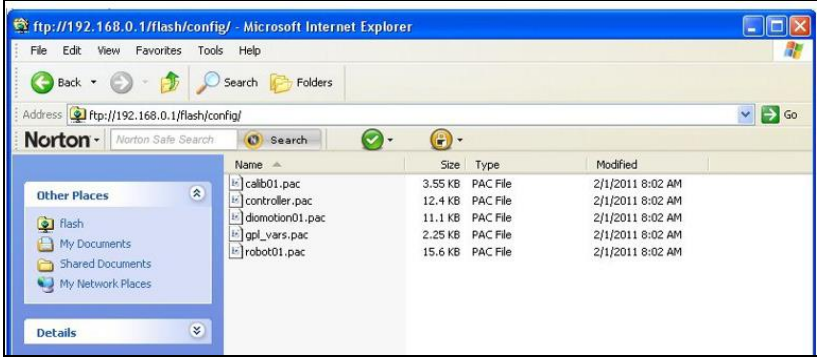
Step	Action
7.	<p>Open the Config folder and paste the backup copy of the PAC files into this folder.</p> 
8.	Wait until the console prompt stops flashing, about 10-15 seconds.
9.	Turn off robot power.
10.	Restore Jumper J8 to its previous position.
11.	Reboot the robot. The PAC files should be restored and the robot should run.
12.	If the robot has ever been recalibrated since the backup PAC files were created, it will be necessary to recalibrate the robot, as the calibration files will be out of date.
13.	Replace the X axis rear cover.

Controller Software Extensions

This section discusses extensions to the standard Guidance Controller software that are specific to the PreciseFlex 100 Robot. Brooks offers a Command Server software package that allows a PC to send high level commands to the PP100 robot. This package is available upon request.

Controlling the PreciseFlex Servo Gripper

Overview

The PreciseFlex Servo Gripper with spring return contains a brushless servo motor with an incremental encoder with both counting and motor phase tracks. At power up, the encoder provides motor commutation information for a brief period, and then switches the incremental encoder A, B and Z signals onto the same set of wires. This allows the motor commutation to be initialized at start-up without any motion.

The motor has a 12-tooth pinion gear cut directly on the motor shaft. This pinion drives a pair of opposing racks to open and close a set of finger mounts which are attached to linear ball slides. Various fingers can be attached to the finger mounts.

One finger mount is also attached to a spring return, which applies a continuous closing force to the finger mounts as they are coupled together by the pinion. Therefore, if power is lost, the gripper will close and maintain a closing force so that it does not drop parts.

In order to avoid the gripper slamming closed from the spring force when motor power is disabled, there is a 500 ms delay after an E-Stop or power disable command is sent before the motor power is cut off. During this period, the servo slowly closes the gripper.

In order to support “free” mode, in which the fingers can be moved back and forth freely by hand, in free mode the servo counterbalances the spring by applying an opposing force based on finger position.

Software Revision

The Spring Gripper functionality is fully supported by GPL version 3.1.P11 or later and PAC files PrecisePlace130S 140901 or later.

Controlling the Gripper

Brooks has created a GPL software routine that controls the spring gripper. This routine includes features for controlling the gripper squeeze force and detecting if a plate is present during a grip. Brooks makes this routine available to customers upon request; email support@preciseflex@brooksautomation.com. This routine is also available in the PreciseFlex Command Server Software for the PF400 and PP100.

Gripper Squeeze (Simple Method)

The spring applies a closing force of approximately 7 Newtons at a finger opening of 103 mm, which is halfway between a portrait titer plate grip at 83 mm and a landscape titer plate grip at 123 mm. The force is closer to 6 N in portrait mode and 8 N in landscape mode and 9-10N at the full open homing position. These closing forces appear adequate to prevent dropping titer plates weighing up to 200 gms and are selected to allow enough motor torque to overcome the spring and still provide reasonable opening force for inside grips.

The motor can apply about 18 N of force at its rated current of 1.26 A. When closing the fingers, the motor adds its force to the spring force, so a maximum closing force of about 24-26 N is possible, depending on portrait or landscape gripping. When opening, the motor must oppose the spring force, so a maximum opening force of about 8- 12 N is possible, depending on the opening of the fingers.

The motor squeeze force can be limited by modifying the rated current of the motor. This can be done by writing into the 5th field in Parameter Data Base # 10611. The motor current can be set once and saved into flash or modified dynamically by a GPL program using the Controller.PDbNum instruction.

The formula for determining the approximate gripper squeeze is $7\text{ N} + (\text{Rated Current}/1.26\text{ Amps}) \times 18\text{ N}$ for squeeze and $(\text{Rated Current}/1.26\text{ Amps}) \times 18\text{ N} - 9\text{ N}$ for gripper opening force.

NOTE: In order to home, the gripper must open all the way its maximum hard stop. The spring force at this point is about 10 N. Therefore, the motor current should not be set below about 12 N/18 NX1.26 A or 0.8 A for the simple method of controlling gripper squeeze, giving a range of about 18 N minimum to 24 N maximum squeeze.

Gripper Squeeze (Asymmetric Method)

There may be cases where 18 N of squeeze is too much. In this case there is a more sophisticated method to control squeeze.

There are two parameters in the database, 10351 and 10352 that can be used to limit the torque from the PID loop in the positive and negative directions. These parameters were developed to limit the downwards force of a robot running with dynamic feedforward, where the dynamic feedforward compensates for the gravity torque of the robot. The feedforward torque is NOT limited by these parameters, only the PID torque. For a perfectly balanced robot, setting these parameters to a low value for a gravity loaded axis limits the maximum force the axis can apply from any position error. If the axis crashes into a hard stop, the downwards or upwards force can be limited to a small value.

These same parameters can be used to limit the gripper squeeze in an asymmetric manner. Parameter 10352 can be set to a negative value of torque counts (tcnts) to limit the torque from the PID loop in the controller in the negative direction only. Parameter 10351 can similarly be set to limit tcnts from the PID loop in the positive direction. Since the spring compensation in the gripper is treated as a feedforward torque, these parameters do not affect the spring compensation torque.

For this case it is more exact to know the exact number of tcnts to oppose the spring at various openings. For the portrait mode opening of 83 mm it takes 1600 tcnts to oppose the spring. For the landscape mode opening of 123 mm it takes 2200 tcnts to oppose the spring.

If the rated torque of the motor has been set to its maximum value of 1.26 A, the formula for setting parameter 10352 is $(\text{Spring force at position}) + ((-\text{Contents of 10352}) - \text{tcnts to oppose spring force}) / 4378) \times 18 \text{ N}$, where 4378 is the number of tcnts corresponding to 1.26 A or the rated torque of the motor. For example, for portrait mode the spring force is about 6 N, and if the contents of 10352 are -3200, this value will be $6 \text{ N} + (3200 - 1600) / 4378 \times 18 \text{ N}$ or about 12.5 N. If the value of 10352 is -1600, the squeeze will be 6 N which is the spring force only.

In a similar manner parameter 10351 can be used to limit the gripper opening force. In this case the value for the opening force is $((\text{Contents of 10351}) - \text{tcnts to oppose spring force}) / 4378 \times 18 \text{ N} - (\text{Spring force at position})$. For example, in landscape mode the spring force is about 8 N, and if the contents of 10351 are 5200, this value will be $(5200 - 2200) / 4378 \times 18 \text{ N} - 8 \text{ N}$ or 4.3 N. Note that 5200 is about as low a value as one would want to use in landscape mode for parameter 10351, to ensure there is enough force to oppose the spring and open the gripper all the way to the homing position. For many cases, 10351 can be left at its default value of 0, in which case it is disabled.

Grip Test and Squeeze Check

It may be desirable to check if a plate is gripped by checking the gripping torque value. The output torque to the motor is available in Parameter 12304, value 5 in the parameter data base. For a non-spring gripper, this value varies between 0 and 4378 tcnts for a maximum gripper force of 18 N. For a spring gripper, per above, for a portrait grip, the spring adds about 1600 tcnts to the squeeze and for a landscape grip, it adds about 2200 torque counts to the squeeze. Since this value is taken into account by the spring compensation and is offset from the torque commanded to the motor in Parameter 12304, when checking Parameter 12304 to determine squeeze the spring compensation must be subtracted from the torque value in Parameter 12304. For example, if the gripper is at the portrait position and not holding a plate, it must servo against the spring. In this case the value in Parameter 12304 will be about 1600 tcnts. To determine the effective squeeze torque, subtract 1600 tcnts from this value, which results in zero tcnts of squeeze force. If the value in 12304 is -2700, then the gripper motor is squeezing with -2700 tcnts, and the spring is adding -1600 tcnts, and the effective squeeze is -4300 tcnts, or about 18 N. The exact spring compensation value is stored in field 5 of Parameter 12331. For the best accuracy in determining effective squeeze force at any gripper opening, subtract this value from the value in 12304.

Servo Gripper Controller Digital Inputs and Outputs

The Servo Gripper Controller PCA (GSB) adds three general optically isolated digital outputs and three general optically isolated digital inputs to the standard digital I/O found on the Guidance Controller. Like the other general inputs and outputs, they can be utilized as remote DIO by the master Guidance Controller for general workcell interfacing; driving an LED, encoder latching inputs for conveyor tracking or camera synchronization; inputs to the GSB servo for homing or limit stops; etc. These signals are presented in an eight-pin AMP 3-794618-8 that mates with an AMP 794617-8 plug. (See [Figure 5-4](#).) This type of connector permits these signals to be easily interfaced to other devices.

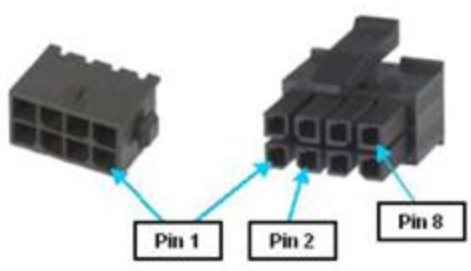

Figure 5-4: Eight-pin AMP 3-794618-8 and an AMP 794617-8 plug

Unlike the controller's standard digital I/O that are directly accessed on demand, these I/O are scanned by the controller. The scanning period is nominally 4 milliseconds, so the application in use must be able to handle a delay of up to 4 milliseconds for signal changes to propagate through the system.

For the PP100, Output 3 of the servo gripper controller is connected to the blue status LED, and so is not available for general IO.

The GSB I/O signals are shown in [Table 5-1](#):

Table 5-1: GSB/IO Signals and Signal Numbers

Pin	GPL Signal Number	Description
1	200013	Digital Output 1
2	200014	Digital Output 2
3	200015	Digital Output 3 (LED on Theta Cover)
4		24VDC output
5		GND
6	210001	Digital Input 1
7	210002	Digital Input 2
8	210003	Digital Input 3

Optional Pneumatic or Vacuum Gripper

It is possible to order an optional pneumatic or vacuum gripper. In these cases, the GSB board provides two outputs and three inputs that can be used to control solenoids and sense end of travel. As a special option the GSB board can be replaced by a GIO optional IO board with 12 inputs and 8 outputs, described earlier. Signals from the GIO board can then be used to control gripper solenoids and IO. In this case the blue status light LED is wired back to the GSB board that drives the Z-axis.

Control of Status Lamp on Theta Cover

Users normally do not need to modify the setting of the status lamp (Digital Output 200015) since the standard robot software typically manages this signal. However, if desired this signal can be manually altered under program control via the GPL SIGNAL.DIO instruction. This is controlled by DOUT signal 200015. If direct control of this signal is desired, DataID 235 should be set to 0 and signal number 200015 should be controlled by program control.

6. Service Procedures

Recommended Tools

The following tools are recommended for these service procedures:

- Gates Sonic Belt Tension Meter, Model 507C for checking timing belt tension.
- A set of metric “stubby” hex L-keys, for example McMaster Carr PN 6112A21 with 1.5, 2.0, 2.5, 3.0, 4, 5, and 6 mm L Keys.
- A set of metric hex drivers including 1.27, 1.5, 2.0, 2.5 and 3.0 mm driver, for example McMaster Carr PN 52975A21.
- A pair of tweezers or needle nose pliers.
- A pair of side angle cutters.
- Small flat bladed screw driver, with 1.5 mm wide blade typical
- M5 socket driver or M5 open end wrench or pliers

Troubleshooting

Precise robots and controllers have an extensive list of error messages. Please refer to the HTML document *PreciseFlex Library* to search for a specific error message and cause. Listed in [Table 6-1](#) are a few errors that may be generated by hardware failures.

Table 6-1: Hardware Failure Errors

Symptom	Recommended Action
System error message generated	
“ESTOP not Enabled”	Check the 9-pin Dsub for the E-stop jumper.
“Encoder Battery Low”	Replace the absolute encoder battery in the X-axis of robot.
“Encoder Battery Down”	If the encoder cable has been disconnected, recalibrate the robot. If the battery voltage has dropped below 2.5V, replace the encoder battery and recalibrate the robot.

Symptom	Recommended Action
"Encoder Operation Error"	Joint rotated too quickly with power off. See "Encoder Operation Error" on page 83.
"Encoder Data, Accel/decel Limit Error"	The encoder cable may be damaged and the encoder may be getting intermittent communication, causing apparent jumps in position. Check the encoder connectors. Replace the cable. Replace the motor.
"Encoder Communication Error"	Check the encoder connectors on flat ribbon cable. Replace the encoder cable or motor/encoder.
"Encoder quadrature error"	Replace the slip ring. Replace the motor/encoder (only the Gripper motor).
"Missing zero index"	See "Encoder Operation Error" on page 83.
"Motor duty cycle exceeded"	Reduce the speed or acceleration of the robot. Check for instability.
"Amplifier under voltage"	The motor power supply has reached current limit and shutdown. Slow down the robot. Check the Energy Dump PCA. Replace the 48V supply.
"Amplifier Fault"	Check the harness and motor for shorts.
"Amplifier Over Voltage"	Check that energy dump resistor is connected.
"Soft Envelope Error"	Make sure that the robot is not pressing against the surface. If this occurs on the gripper repeatedly, replace the slip ring.
"Hard Envelope Error"	This symptom typically means that the robot has crashed into something.
Pneumatic Gripper Sensor not working	Check the continuity of the cable through the wrist. Check the green lights on the sensor to see if the sensor is triggering.
"Time Out Nulling Error"	Check that joint is free to move with the brake off. Check that the joint is not vibrating or unstable. If unstable check the belt tension. If Gripper, replace the slip ring after checking that the brake releases.
"Joint Out of Range"	The joint actual or commanded position may be beyond the software limit stop. Move the joint back into range while monitoring the virtual pendant or check the program for commanded position.
"PAC Files Corrupted"	See "Recovering from Corrupted PAC Files" on page 73.
Physical or audible problem	
Brown streaks on linear bearing	Clean with alcohol and add grease to the bearing blocks. This should not be required sooner than 20,000 hours of run time. Grease is Alvania Grease EP2 from Shell.
Mechanical noise from any joint	Check the joint bearings for failure. Re-tension the belt.
Loud buzzing or vibration from any joint	Re-tension the timing belts.

Encoder Operation Error

The PF100 robot is equipped with absolute encoders that keep track of the robot position even when AC power to the robot is disconnected. There is a battery in the base of the robot that provides standby power to the encoders. In standby mode, there is a limit on how quickly the motor can turn and still have the standby counter operate properly. The limits are 6,000 rpm and 4000 rad/s². Even at 100% speeds, the robot joints normally do not move faster than about 2,000 rpm and 1300 rad/s². However, if the robot is shocked during shipping, it is possible the standby operation acceleration error limit may be exceeded. This can generate an encoder operation error that will prevent the robot from homing after power up.

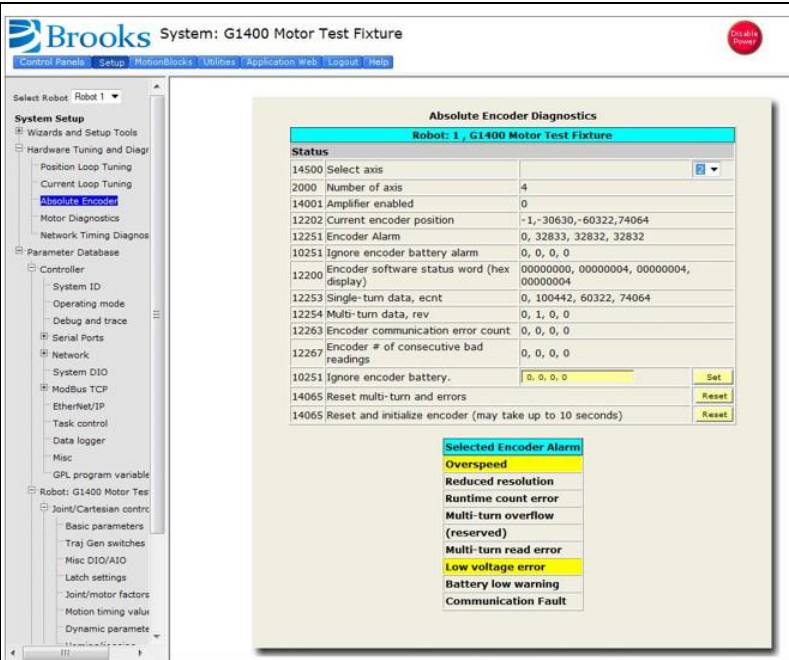

This error will be displayed in the Operator Window of the Web Interface as “Encoder Operation Error” Robot 1: <axis number>.

Assuming the robot has not been damaged by the shipping process, this error can be reset by the following procedure:

Step	Procedure
1.	Access the Web Operator Interface to the robot with either “Maintenance” or “Administrator” privileges.
2.	<p>From the Setup menu, select System Setup→Hardware Tuning and Diagnostics→Absolute Encoder.</p> 

Step	Procedure
3.	<p>In the drop-down menu at the top right of the screen, select the robot axis that was associated with the error and check to see if the Overspeed panel is yellow. This indicates an overspeed error during encoder standby mode due to shock or vibration. This error can be reset by selecting the Reset button next to Reset and initialize encoder. This button resets error flags but does not reset the encoder counters. The robot can then be homed normally.</p>
4.	<p>For cases where the encoder operation error was triggered by shipping vibration, IN MOST CASES the encoder will not have lost any position data. However, after homing the robot, it is a good idea to move the robot to the calibration position (using the calibration pins where required desired), or another known position, and check the joint angles in the Virtual Pendant in the Web Operator Interface. The joint angles in the Calibration Position are:</p> <ul style="list-style-type: none"> • X-axis at hard stop opposite connector panel: -2 mm • Z-axis at upper hard stop: -2 mm • Theta axis when rotated to negative hard stop and reversed to calibration pin: -270 degrees for the X • Gripper closed with power off after calibration: 72 mm <p>If the robot joints after this procedure followed by homing are different from the above, then the robot needs to be re-calibrated.</p>

Replacing the Encoder Battery

 DANGER Electrical Shock	
<p>Improper electrical connection or connection to an improper electrical supply can result in electrical shock, burns, fire, and damage to the equipment and death or serious injury.</p> <ul style="list-style-type: none"> • Before replacing the encoder battery, the AC power should be disconnected. Removing the rear cover allows access to the AC power terminals. 	

The Encoder Battery is designed to last for several years with robot power turned off. With robot power turned on, there is no drain on the battery. The battery voltage is monitored by the system. The nominal battery voltage is 3.6 Volts. If the battery voltage drops to 3.2 Volts an error message “Encoder Battery Low” is generated. At this level the absolute encoder backup function will still work, however the Battery should be replaced. If the voltage drops to 2.75 Volts, an error message “Absolute Encoder Down” is generated. At this point, the absolute encoder backup function will not work.

Note that if any motor/encoder is disconnected from the encoder battery by disconnecting the encoder cable, the “Encoder Battery Low” or Encoder Battery Down” message will be generated.

However, in this case, the encoder battery does not need to be replaced. It is only necessary to re-calibrate the robot, see [Figure 6-1](#).

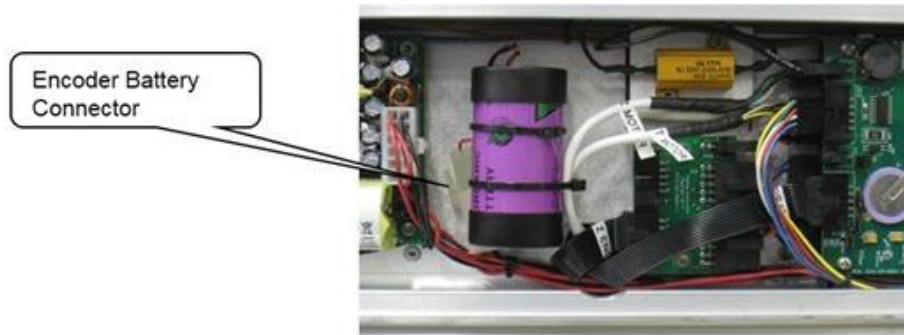

Figure 6-1: Encoder Battery Connector

Tools Required:

- 3.0 mm hex driver or hex L wrench

Parts Required:

- New Encoder Battery (PN PF00-EA-00002)
- 2 8 in long by .093 wide tie wraps

To replace the Encoder Battery, perform the following procedure:

Step	Action
1.	Turn off power to the robot and remove the AC power plug.
2.	Remove the Rear Cover of the X-axis.
3.	The Encoder Battery is located in the middle of the electronics in the X-axis. The Encoder Battery has a connector which plugs into a connector in the controller harness. Unplug the old battery and replace with a new battery. It may be necessary to recalibrate the robot after the battery has been replaced. The encoders have standby capacitors that allow the old battery to be disconnected for a few minutes while a new battery is installed, without losing calibration, but these capacitors age over time and may not hold their charge very long.
4.	Attach the new Encoder Battery to the hold down with one tie wrap and replace the second tie wrap securing the motor cables to the encoder battery.
5.	Replace the rear cover.

If the error message “Encoder Battery Down” was generated, the robot must be re-calibrated after this procedure.

Calibrating the Robot: Setting the Encoder Zero Positions

Cal_PP is a service program that must be run to set the zero positions of the absolute encoders on each motor. The zero positions must be re-established if any of the motors are replaced, their cables disconnected for a long duration, or the encoder backup battery has been disconnected.



Cal_PP is supplied on the *Guidance Controller System Software CD*. To run Cal_PP, the controller must be configured to run GPL programs and Cal_PP must be loaded into the controller's memory (See "[Appendix D: Preventive Maintenance](#)" on page 120).

Tools Required:

- 2.5 mm and 3.0 mm hex drivers or hex L wrenches
- Set of 1 Calibration Dowel Pin, located in a plastic bag inside the Z motor cover under the Z motor pulley.

The following describes the procedure for defining the zero positions of the PF400 robot axes using Cal_PP.

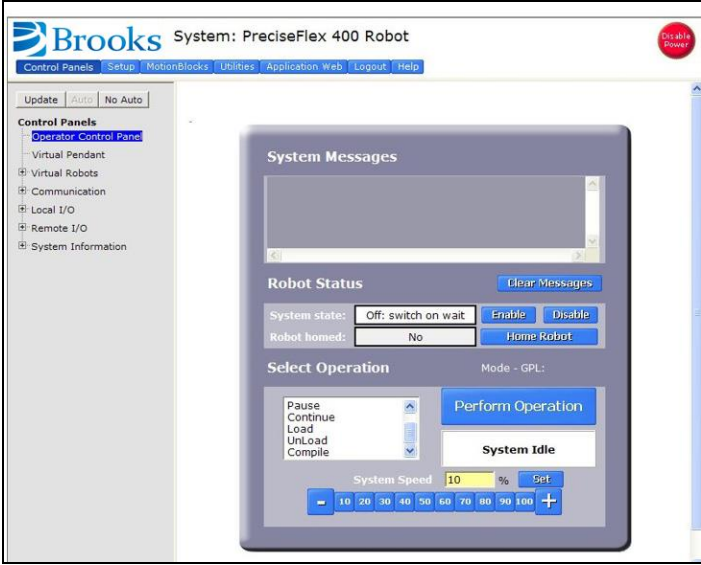
Step	Action
1.	Enable power to the robot's controller, but do not turn on power to the motors. (This procedure should be executed with motor power off. The robot does not move.)

Step	Action
<p>2.</p>	<p>The CALPP program is typically installed at the factory and should be loaded into flash memory. Using the Web based Operator Control Panel first unload any currently loaded programs. Select the Unload item in the left scrolling window and press the Perform Operation button. This ensures that no GPL project is currently selected for execution. Select the Load item and press Perform Operation. This displays a list of projects that are in the flash disk and available for execution. In the popup display, click CALPP_RevXX and click Select. When ready to execute the project, select Start application and click Perform Operation. If CALPP is not loaded in the robot, first Load Cal_PP into the controller's memory from a PC, using the web Operator Control Panel, as described in Software Reference.</p> 
<p>3.</p>	<p>Manually move the robot into the following configuration. (XZTheta robot shown)</p> 
<p>4.</p>	<p>Ensure that the X-axis is against the hard stop opposite the connector end cap.</p>

Step	Action
5.	Ensure that the Z-axis is at the hard stop at the top of the range of travel. To do this, first release the Z-axis brake by pushing on the Brake Release button at the back of the Z -axis cover. Make sure to support the robot arm by hand and raise the robot arm gently until it rests against the upper hard stop.
6.	Remove the 3 mm tapered calibration pin from the plastic bag under the Z-axis cover, under the Z-axis motor.
7.	Rotate the Theta axis all the way to the negative hard stop (counter-clockwise looking down at Theta), then rotate it back about 20 degrees and insert the tapered dowel pin in the 3 mm hole in the bottom of the Theta axis. Rotate the Theta axis back in the negative direction until the gripper housing presses against the dowel pin. If the axis springs away from the pin due to the wire harness clock spring wind up, use masking tape to hold the gripper housing against the pin.

Step	Action
8.	<p>With the CALPP application loaded, select Start Application, and then press Perform Operation.</p> <p>The application should start and prompt for a confirmation of the correct robot position for calibration.</p> <div data-bbox="511 447 1125 1119" style="border: 1px solid gray; padding: 10px; margin: 20px auto; width: fit-content;"><p style="text-align: center;">System Messages</p><div style="border: 1px solid gray; padding: 5px; margin-bottom: 5px;"><p style="text-align: center;">GPL Dialog</p></div><p style="text-align: center;">Encoder Zero Position Calibration, Rev 16</p><p style="text-align: center;">*** WARNING ***</p><p>Executing this procedure modifies the zero positions of some or all of the robot's axes. You should only execute this procedure if you have read the Service Chapter of your robot's Hardware Manual and are sure that you wish to PERMANENTLY change this robot's calibration data.</p><p>Robot type:</p><p style="text-align: center;">PRECISEFLEX 400</p><p style="text-align: center;"><input type="button" value="Continue"/> <input type="button" value="Quit"/></p></div> <p style="text-align: center;">System Speed <input type="text" value="10"/> % <input type="button" value="Set"/></p> <p style="text-align: center;"><input type="button" value="-"/> 10 20 30 40 50 60 70 80 90 100 <input type="button" value="+"/> <input type="button" value="Set"/></p>

Step	Action
	<div data-bbox="540 310 1159 982" style="border: 1px solid gray; padding: 10px; margin: 10px auto; width: fit-content;"> <p>This robot has ABSOLUTE ENCODERS in one or more axes. This procedure can either: (1) clear all absolute encoder multi-turn counters AND set the zero position of all axes, or (2) just clear all absolute encoder multi-turn counters. The first procedure must be performed if the zero position of any axis must be set. However, due to inaccuracies inherent in this procedure, after the zero positions are set, any taught points must normally be retouched. The second procedure can be performed if the axis zero positions are set but the absolute encoders have lost their battery power. This will permit formerly taught locations to continue to work properly.</p> <p>Please select what is to be done:</p> <p><input type="checkbox"/> Clear multi-turn counters and set axis zero positions</p> <p><input type="checkbox"/> Only clear multi-turn counters</p> <p><input type="checkbox"/> Quit Cal_PP</p> <p style="text-align: center;">- 10 20 30 40 50 60 70 80 90 100 +</p> </div> <p>The CALPP application takes about 1 minute to run.</p>
9.	After calibration is complete, use the Brake Release button to move the Z-axis up from the hard stop. Failing to do this will produce an error as the robot is outside of the soft stop limits.
10.	Make sure that the pin is removed.
11.	Enable power and home the robot. Calibration does not take effect until the robot is homed.



Replacing Belts and Motors

The timing belts and motors are designed to last the life of the robot. It is not expected that they will need to be replaced in the field. In most cases, if a belt or a motor needs to be replaced, the robot should be returned to the factory. While there are procedures at the end of this manual for replacing belts and motors, only experienced service technicians should attempt these procedures.

General Belt Tensioning

The PreciseFlex 100 has been designed to make belt tensioning very simple. See "[Appendix E: Belt Tensions, Gates Tension Meter](#)" on page 121 for belt tension specifications.

Tensioning the X-axis Belt

 DANGER Electrical Shock	
<p>Working with energized equipment may cause electrical shock and may result in serious injury or death. Removing the front cover allows access to the AC power terminals.</p> <ul style="list-style-type: none"> Disconnect the AC power before tensioning the timing belts or replacing any motors. 	

Tools Required



- 2.0 mm hex driver or hex L wrench
- 3.0 mm hex driver or hex L wrench

To adjust tension in the X-axis Belt, perform the following procedure:

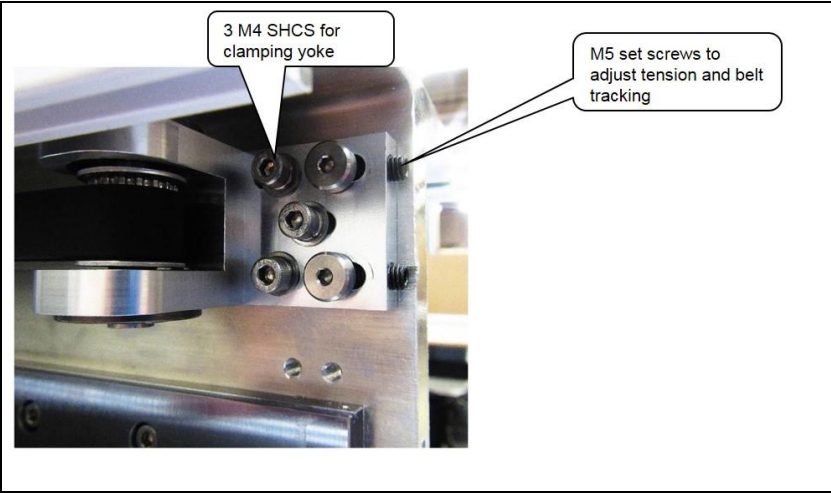
Step	Action
1.	Turn off robot power and remove the AC power cord.
2.	Loosen the tape seal of the robot by removing the (4) M3 socket head screws that attach the tape seal brackets to the vertical Z riser plate. Once the screws are removed, pull the tape seal ends and the tape seal out of the X-axis extrusion grooves so that the X carriage can slide back and forth without dragging the tape seals.
3.	Remove the right end cap by removing the (1) M3 X 10 mm FHCS from the rear cover and the (4) M4 X 35 mm SHCS from the end cap.
4.	Loosen the (3) M4 screws that clamp the right end pulley yoke to the X extrusion.
5.	Move the X carriage to a position so that there is 500 mm from the carriage to the right end pulley yoke where the belt is tangent to the yoke, to set the belt span to 500 mm.
6.	Measure the belt tension with the Gates belt tension meter using the settings in " Appendix E: Belt Tensions, Gates Tension Meter " on page 121. Measure the belt tension by holding the microphone close to the belt in the middle of the 500 mm span and gently plucking the belt.
7.	Adjust the belt tension by turning the belt tensioning set screws in the pulley yoke.
8.	Run the X carriage back and forth a few times to check the belt tracking. Adjust the set screws if necessary to make sure that the yoke is parallel to the X-axis and that the belt is tracking in the pulley and not pressing against the pulley flange.

Step	Action
9.	<p>Tighten the M4 screws to lock down the yoke and replace the end cap and tape seals.</p> 

Replacing the X-axis Motor Assembly

 DANGER Electrical Shock	
<p>Working with energized equipment may cause electrical shock and may result in serious injury or death.</p> <ul style="list-style-type: none"> Remove the AC power before replacing the X-axis Motor. 	

Tools Required



- 3.0 mm hex driver or hex L wrench
- 2.0 mm hex driver or hex L wrench
- Loctite 243

To replace the X-axis motor assembly, perform the following procedure:

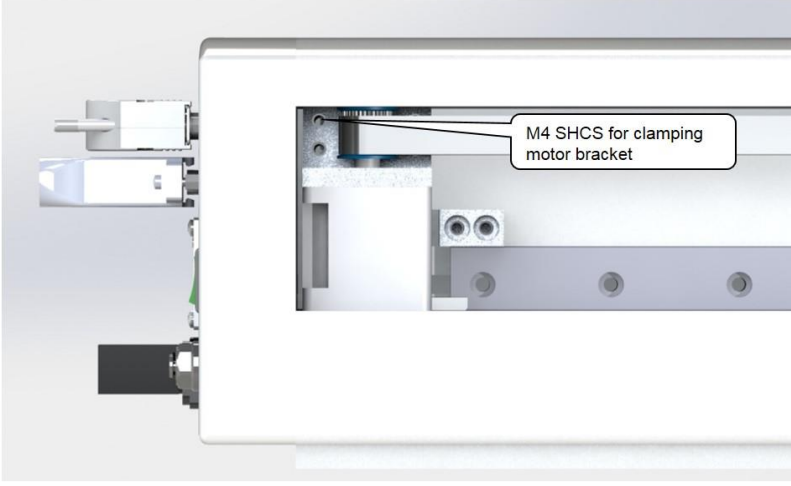
Step	Action
1.	Remove the rear cover from the X-axis.
2.	Unplug the X-axis motor and encoder connectors from the controller. (Refer to "Replacing the Power Supplies or Controller" on page 101 for detail on these connectors.)
3.	Remove both tape seal brackets from the X carriage.
4.	Remove the right end cap by removing the (4) M4 X 35 mm SHCS and (1) M3 X 10 mm FHCS from the rear panel.
5.	Loosen the (3) M4 SHCS that clamp the tension yoke to release the belt tension and back out the M5 set screws that tension the belt.
6.	Remove the left end cap by removing the (4) M4 X 35 mm SHCS.
7.	Remove the X-axis motor and motor bracket by removing the (4) M4 X 12 mm SHCS.
8.	Remove the X axis motor assembly from the motor bracket by removing 2 M4 X 10 SHCS.
9.	Install the new motor and re-assemble components using Loctite 243 to attach the motor to the motor bracket and the motor bracket to the X extrusion. Plug the motor into the controller.
10.	Re-tension the X-axis belt per instructions above.

Step	Action
11.	<p>Recalibrate the robot.</p> 

Replacing the X-axis Timing Belt

 <p>DANGER Electrical Shock</p>	
<p>Working with energized equipment may cause electrical shock and may result in serious injury or death.</p> <ul style="list-style-type: none"> Remove the AC power before replacing the X-axis Timing Belt. 	

Tools Required

- 3.0 mm hex driver or hex L wrench
- 2.0 mm hex driver or hex L wrench
- Loctite 243

To replace the X-axis timing belt, perform the following procedure:

Step	Action
1.	<p>It is not necessary to remove the Z-axis for this procedure. The Z-axis has been removed in the picture below for clarity.</p>

Step	Action
2.	Remove the rear cover from the X-axis.
3.	Remove both tape seal brackets from the X carriage.
4.	Remove the Tension Screw from the right end cap and remove the right end cap by removing the (4) M4 X 35 mm SHCS.
5.	Remove the (4) M4 X 16 mm SHCS that clamp the tension yoke to release the belt tension and free the yoke.
6.	Remove the stop block by removing the (2) M4 X 20 mm SHCS.
7.	Unplug the robot cables going from the E-chain through the hole in the X extrusion to the robot controller.
8.	Cut the tie wraps holding the harness to the E-chain end bracket.
9.	Remove the (2) M3 X 6 mm FHCS attaching the E-chain end bracket to the X extrusion.
10.	Loosen all the M4 SHCS screws that attach the linear rail about two turns.
11.	Slide the linear rail about 150 mm out the right end of the X extrusion. It is a good idea to put a tie wrap through the last M4 clamping hole in the linear rail so that the carriage cannot slide off the rail, which can cause the bearing block balls to fall out of the bearing block.
12.	Unhook the X belt from the X motor pulley and slide the X carriage out past the end of the X extrusion on the linear rail. Be careful not to slide it off the rail, per above. It is now possible to access the X-axis belt clamp.
13.	Remove the (4) M3 X 12 mm SHCS and lock washers retain the belt clamp.
14.	Thread the new belt through the tension yoke and pulley and clamp with the belt clamp. Make sure that the belt is centered under the belt clamp.

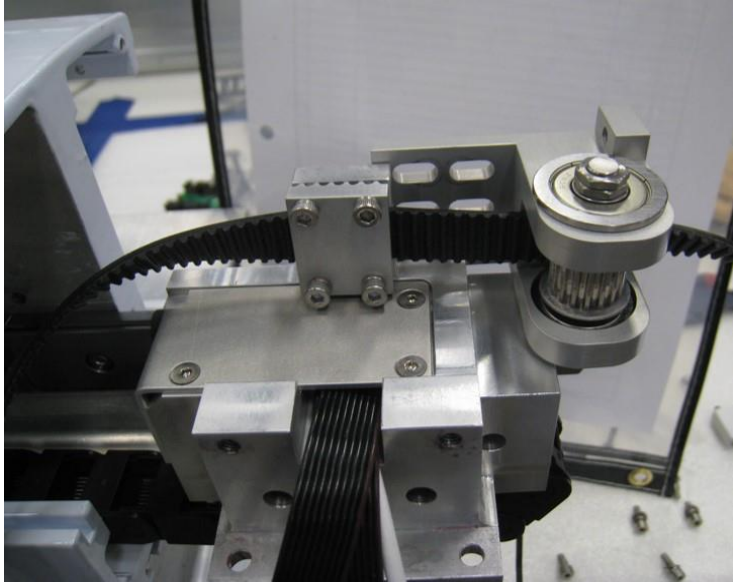
Step	Action
15.	<p>Re-assemble the robot. When re-attaching the E-chain bracket to the X extrusion, first install the M3 X 6 mm FHCS to attach the E-chain bracket. Then pull the cables in the E-chain tight, mark the cables with a pen at the bracket, and then push the cables 5 mm back into the E-chain so that the cables are floating in the E-chain and not stretched tight. Secure the harness with (2) tie wraps around the E-chain bracket fingers.</p> 

Tensioning the Z-axis Output Belt

Tools Required

- Gates Sonic Belt Tension Meter, Model 507C
- 3.0 mm hex driver or hex L wrench

To tension the Z-axis Belt, perform the following procedure:

Step	Action
1.	Turn off the robot power and remove the AC power cord.
2.	For the 228 mm Z stroke robot, move the Z-axis all the way to the top of the stroke using the brake release button. For the 260 mm Z stroke robot move the Z-axis so the distance from the upper belt roller to the top end of the belt is 236 mm.
3.	Use the belt tension meter with the settings in " Appendix E: Belt Tensions, Gates Tension Meter " on page 121 to measure and adjust the belt tension. Hold the microphone perpendicular to the belt and gently pluck the belt using an L key.
4.	<p>Adjust the belt tension by turning the Tension Adjustment Screw. After adjusting the tension, run the Z-axis up and down a few times using the brake release switch, then check the tension again.</p>  <p>The diagram shows a 3D perspective view of the Z-axis assembly. A callout box labeled 'Tension Adjustment Screw' points to a screw on the top of the vertical shaft. Another callout box points to the distance between the belt clamp and the end cap, with the text: 'Set this distance to belt clamp in end cap to 236mm using brake release button to set span for belt.'</p>

Tensioning or Replacing the Z-axis Motor and Timing Belt



Tools Required

- Gates Sonic Belt Tension Meter, Model 507C
- 4.0 mm hex driver or hex L wrench
- 8 mm open end wrench
- 7 mm open end wrench

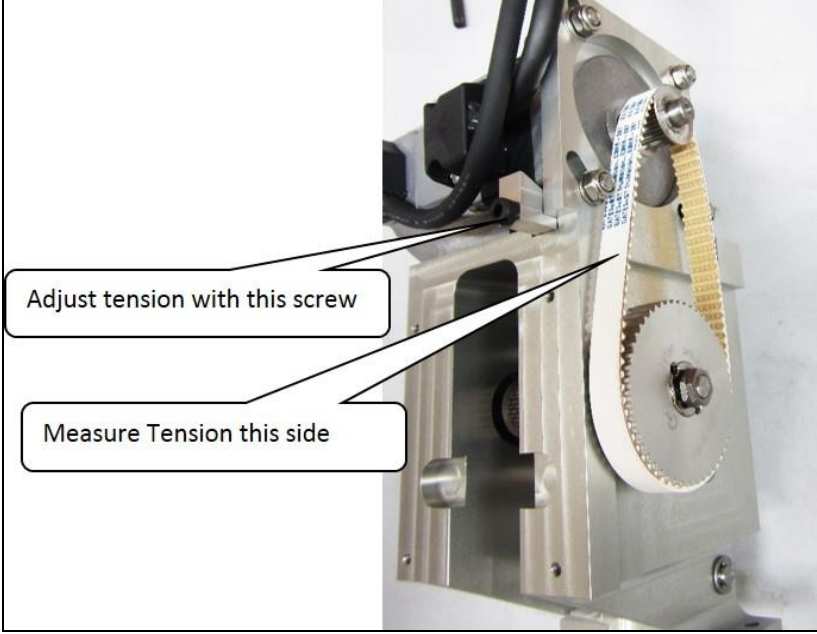
To tension or replace the Z-axis motor or timing belt, perform the following procedure:

Step	Action
1.	Turn off the robot power and remove the AC power cord.
2.	Remove the Z drive plastic cover by removing the (4) M3 X 10 mm Button Head Screws.
3.	Use the belt tension meter with the settings in Appendix E to measure and adjust the belt tension. Hold the microphone perpendicular to the belt and gently pluck the belt using an L key.
4.	<p>Adjust the belt tension by first loosening the (4) motor retaining bolts, and then adjusting the tension screw with a 3 mm hex driver.</p> <p>After adjusting the tension and tightening the screws, run the Z-axis up and down a few times using the brake release switch, and then check the tension again.</p>  <p>Adjust tension with this screw</p> <p>Measure Tension this side</p>
5.	Replace the Z drive plastic cover.
6.	If the motor or belt has been replaced, the robot must be re-calibrated.

Replacing the Theta Axis Motor

 DANGER Electrical Shock	
<p>Working with energized equipment may cause electrical shock and may result in serious injury or death.</p> <ul style="list-style-type: none">Remove the AC power before replacing the Theta Motor.	

Tools Required

- 3.0 mm hex driver or hex L wrench
- 2.5 mm hex driver or hex L wrench
- 2.0 mm hex driver or hex L wrench
- Fine point tweezers
- .06 in flat blade screwdriver

Spare Parts Required:



- Theta Motor Assembly
- Loctite 243

The Theta Motor Assembly is composed of the Theta motor and connectors. To replace the Theta Axis Motor, perform the following procedure:

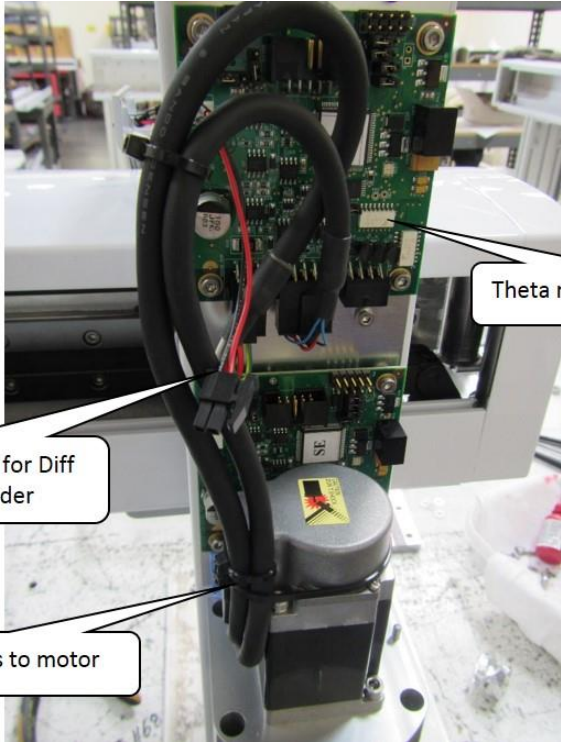
Step	Action
1.	Remove the theta cover by removing the (2) M3 SHCS holding down the light bar and the (4) M3 X 8 mm BHCS attaching the theta cover to the theta frame.
2.	Unplug the theta motor from the GSB "Diff" board.
3.	Remove the (2) M4 X 12 mm SHCS attaching the theta motor.
4.	Loosen the (2) M3 X 8 mm SHCS in the helical coupling clamping the motor shaft.
5.	Remove and replace the motor.
6.	Replace the M4 X 12 mm SHCS using Loctite 243.
7.	Tighten the (2) M3 screws in helical coupling.
8.	Plug in the motor connectors.

Step	Action
9.	Secure the motor cables in a loop around the left side of the motor where the connectors are using tie wraps so the cables are clamped tightly to the motor as shown below.
10.	Replace the cover.
11.	Recalibrate the robot.  <p data-bbox="1052 751 1344 814">Theta motor controller</p> <p data-bbox="332 926 686 1003">Battery backup pigtail for Diff GSB for absolute encoder</p> <p data-bbox="407 1119 719 1182">Tie wrap cables to motor</p>

Replacing the Power Supplies or Controller

 DANGER Electrical Shock	
<p>Working with energized equipment may cause electrical shock and may result in serious injury or death.</p> <ul style="list-style-type: none">• Remove the AC power before replacing the power supplies.	

Tools Required

- 2.0 mm hex driver or hex L wrench
- 2.5 mm hex driver or hex L wrench
- Tie wraps, prefer .093 in by 8 in black.

Spare Parts Required:

- 24VDC power supply (PN PS10-EP-00125) or
- 48VDC power supply (PN PS10-EP-48365) or
- G1400D controller (PN G1XF-EA-A1400)

To replace the power supplies or controller, perform the following procedure:

Step	Action
1.	Turn off the robot power and remove the AC power cord.
2.	Remove the rear cover from the X-axis.
3.	Remove the power supply or controller.

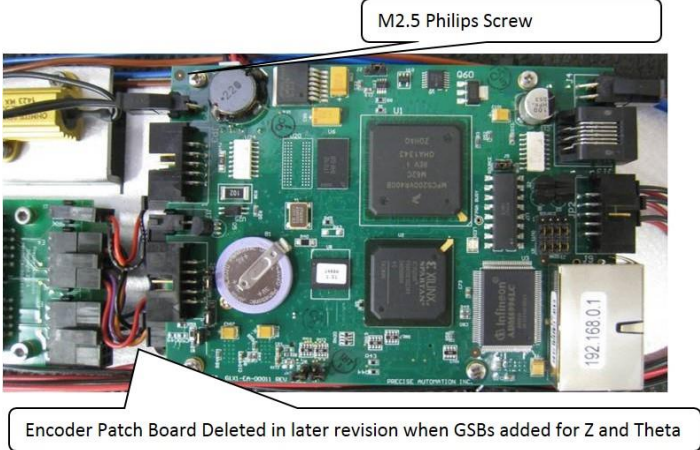

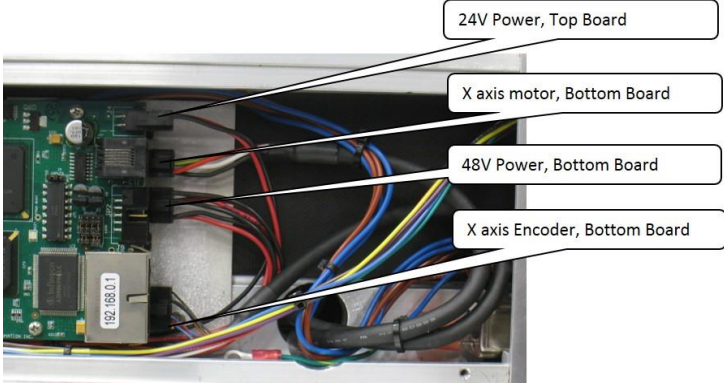
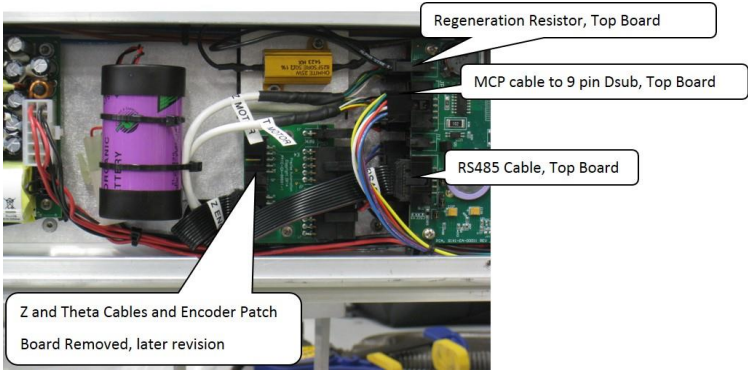
Step	Action
<p>4.</p>	<p>If replacing the 48 Volt power supply, it is important to swap the power enable jumper from the old power supply to the replacement power supply. There is no power enable jumper on the 24 Volt supply.</p> 
<p>5.</p>	<p>If replacing the controller, the user must carefully set all the jumpers on the replacement controller to be the same as the jumpers on the old controller. NOTE: Some jumpers may be changed from factory default settings by users to configure IO settings.</p>
<p>6.</p>	<p>To replace the controller, first disconnect the cables, then remove the (4) M2.5 Philips or Socket Head Screws that attach the CPU board to the amplifier board standoffs and unplug the CPU board from the amplifier board connector.</p> 

Step	Action
7.	<p>Remove the amplifier board standoffs which attach the amplifier board to the X-axis controller sheet metal standoffs.</p> 
8.	<p>Reconnect the cables as shown.</p> 
9.	Replace the rear cover.
10.	Recalibrate the robot.

Replacing the Main Harness

Replacement of the Main Robot Harness is typically only performed at the factory. The Main Robot Harness is intended to last for the life of the robot.

Replacing the Servo Gripper Controller

 DANGER Electrical Shock	
<p>Working with energized equipment may cause electrical shock and may result in serious injury or death.</p> <ul style="list-style-type: none"> Remove the AC power before replacing the Gripper Control. 	

Tools Required

- 2.0 mm hex driver or hex L wrench
- 2.5 mm hex driver or hex L wrench

Spare Parts Required:

- Guidance Gripper Controller (P/N G1X0-EA-T1101)

To replace the Gripper Controller, perform the following procedure:

Step	Action
1.	Turn off the robot power and remove the AC power cord.
2.	Remove the Theta Cover.
3.	Remove the Gripper Controller by removing the (4) M3 X 8 mm SHCS and unplugging the cables.
4.	Replace the Gripper Controller and re-attach the harness.
5.	Replace the Theta Link Cover.
6.	It is not necessary to recalibrate the robot after replacing the Gripper Controller.

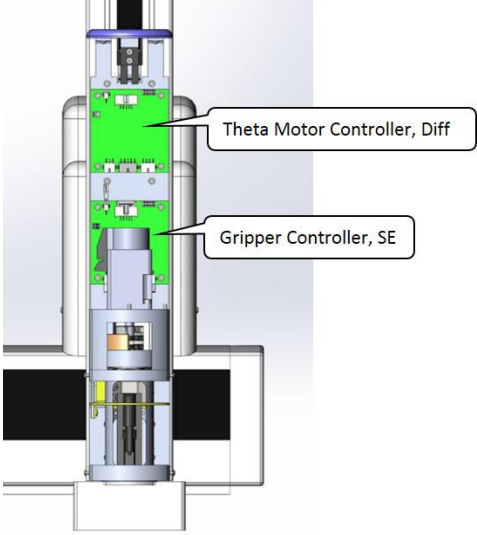
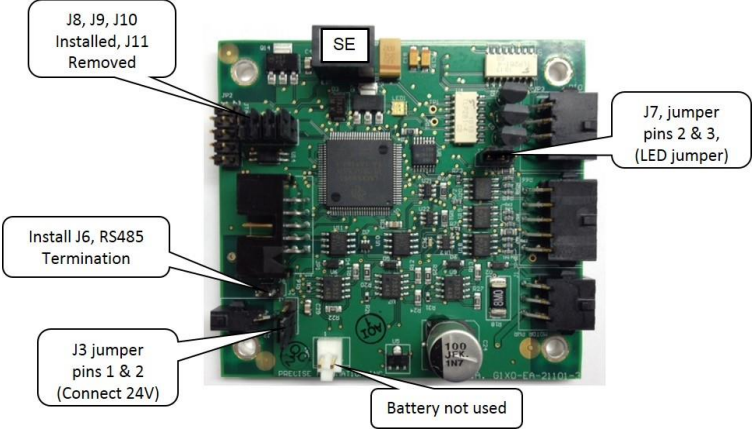
Step	Action
7.	<p>Starting January of 2013 gripper controllers are a new rev (GSB3), which replaces the address DIP switch with jumpers.</p>  <p>The diagram shows a cross-section of a gripper assembly. Two green PCBs are highlighted. The upper one is labeled 'Theta Motor Controller, Diff' and the lower one is labeled 'Gripper Controller, SE'.</p>
8.	<p>To make the SW in the GSB3 work in a compatible mode with the standard PAC files, Jumper J11 must be removed.</p>  <p>The diagram shows the Gripper Controller, SE PCB with several callouts:<ul style="list-style-type: none">J8, J9, J10 Installed, J11 RemovedJ7, jumper pins 2 & 3, (LED jumper)Install J6, RS485 TerminationJ3 jumper pins 1 & 2 (Connect 24V)Battery not used</p>

Wiring for Pneumatic Gripper

The PP100 can be ordered without the theta axis and servo gripper or with the theta axis and without the servo gripper. In this case, the optional remote IO board “GIO” is installed on the Z-axis and a cable from this board to a 25-pin Dsub on the bottom of a shorter Z-axis cover is installed. Also, two air lines are connected from the X-axis end cap to the two outer Legris fittings on the bottom of the Z-axis cover, as shown in [Figure 6-2](#) and [Figure 6-3](#).

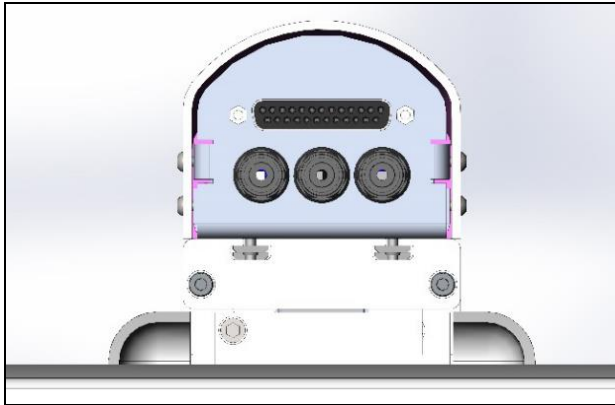

Figure 6-2: Air Line Connection

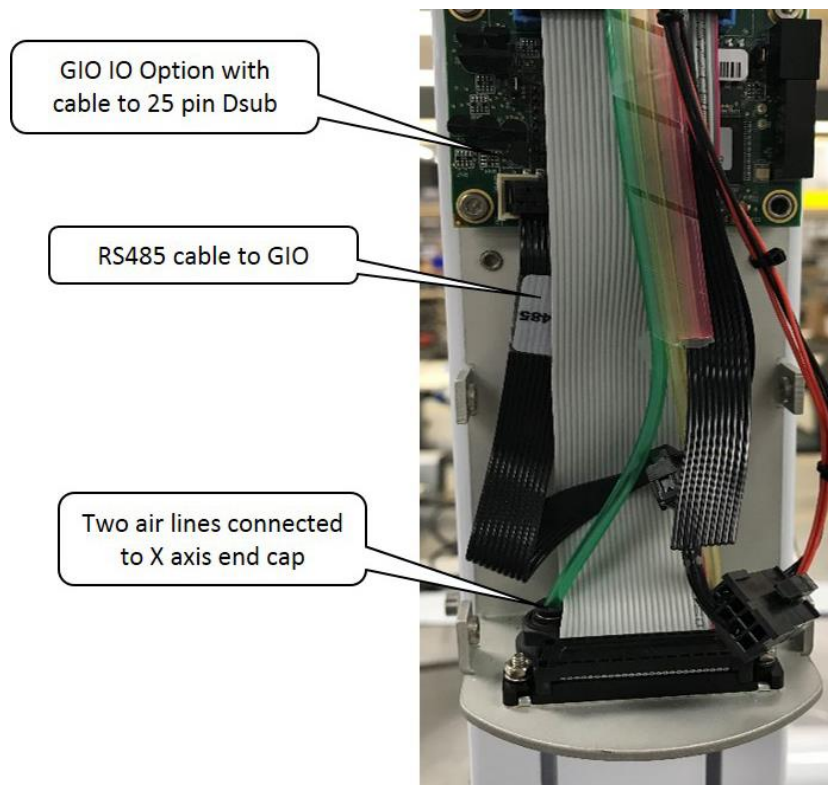

Figure 6-3: Air Line Connection

For this GIO, it is configured (see [Table 6-2](#)) as "GIO6" so the 8 outputs will be addressed as 600013-600020 and the 12 inputs will be addressed as 610001-610012.

Table 6-2: GIO Configuration

	Signal Offset	GIO Module	
		Outputs (8)	Inputs (12)
To specify a GIO's general-purpose digital I/O signal from the master controller, multiply the GIO's network node number (not the GIO's unit number) by 100000 and add the I/O signal's number. For example, to access a GIO board configured as the 2nd or nth network node, add 200000 or 100000*n to the signal number. Node			
2	200000	200013-200020	210001-210012
n	100000*n	n00013-n00020	n10001-n10012

See jumpers in [Figure 6-4](#). Inputs and outputs are 24VDC with outputs limited to 100 mA. For pin assignments on the 25-pin Dsub, see [RS485 Remote IO Module \(GIO\)](#).

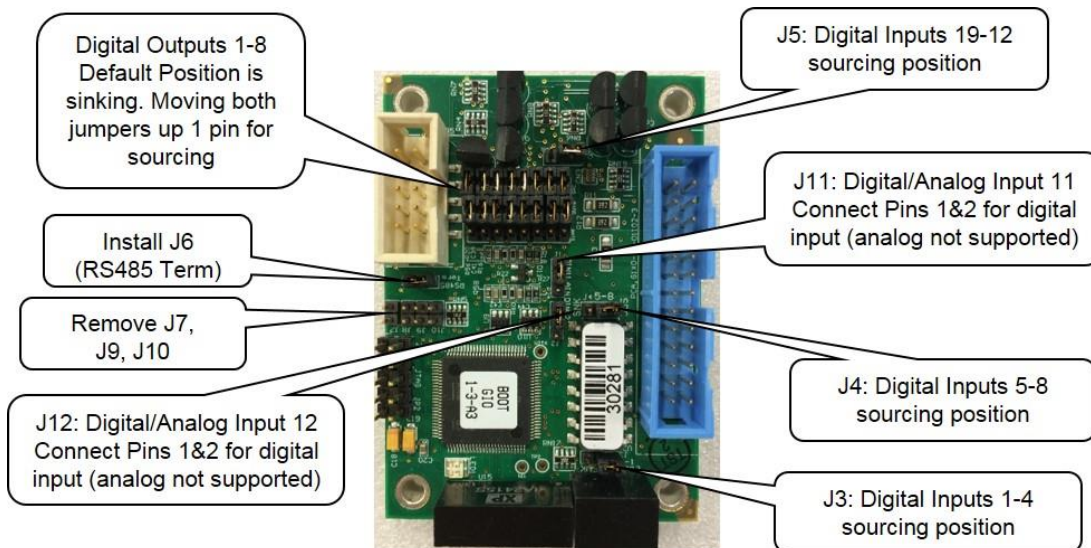

Figure 6-4: GIO Jumpers, GIO_6

Replacing the Gripper Spring or Cable

Tools Required:

- 2.0 mm hex driver
- 2.5 mm hex driver

Spare Parts Required

- Spring or Cable Assembly

To replace the spring or cable, perform the following procedure:

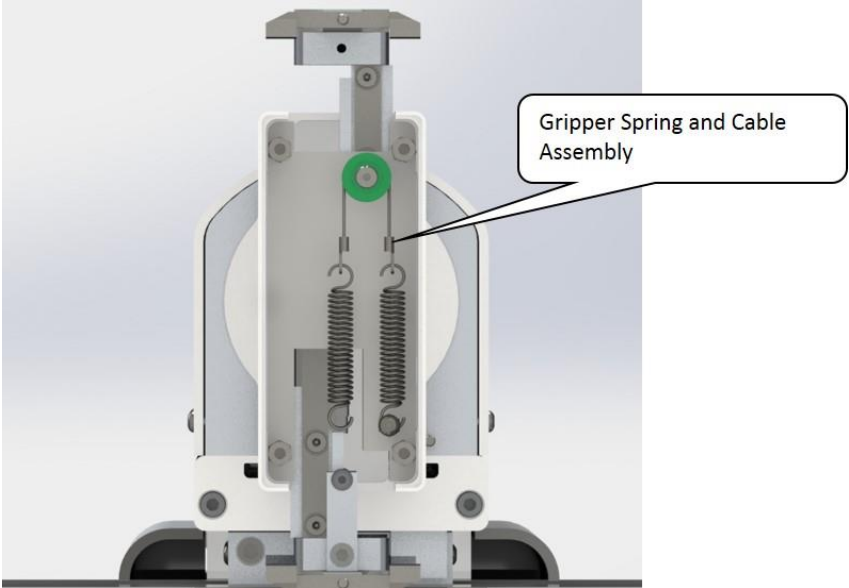
Step	Action
1.	Remove the Gripper Cover by removing the (4) M3 X 6 mm FHCS.
2.	Remove the spring cable assembly by unhooking it as shown in Step 3 .
3.	<p>Replace the spring cable assembly and replace the cover. Do not use Loctite on the screws.</p> 

Adjusting the Gripper Backlash

Tools Required:

- 1.3 mm “stubby” hex L wrench
- 1.5 mm “stubby” hex L wrench
- 2.0 mm hex driver or L wrench
- Loctite 243 medium strength screw lock
- Mobil 222 HP grease if needed



Spare Parts Required:

- None

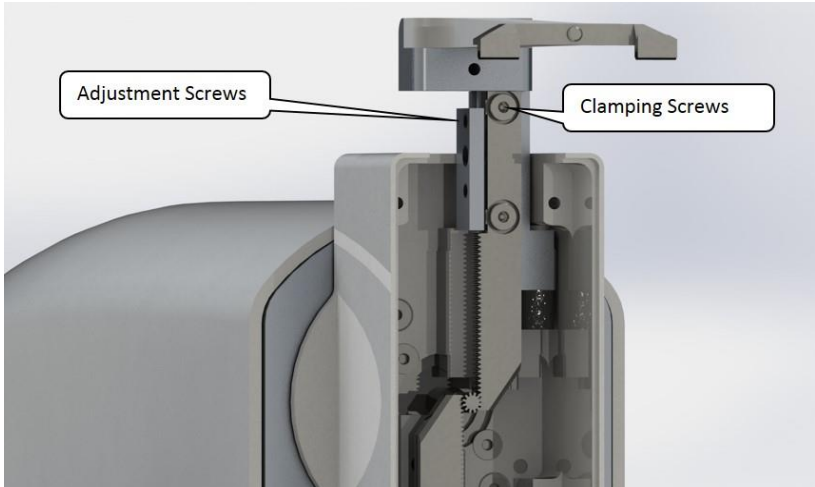
To adjust the gripper backlash, follow this procedure:

Step	Action
1.	Remove the Gripper Cover by removing the (4) 32 X 6 mm FHCS.
2.	Unhook the gripper spring assembly and remove it.
3.	Remove the gripper spring plate by removing the (4) M3 standoffs that attach the plate.
4.	Move the racks back and forth to determine which rack has backlash and where it is located on the rack.
5.	Loosen the (2) M3 X 8 mm LHCS clamping the rack to the finger mount.
6.	Adjust the M2 SHCS and M3 set screws to adjust the rack backlash.
7.	Remove the (2) M3 X 8 mm SHCS one at a time, apply Loctite 243 screwlock, reinstall and tighten. 

Replacing the Gripper Harness

 DANGER Electrical Shock	
<p>Working with energized equipment may cause electrical shock and may result in serious injury or death.</p> <ul style="list-style-type: none"> Remove the AC power before replacing the Gripper Harness. 	

Tools Required:

- 2.0 mm hex driver or hex L wrench
- .093 in by 8 in tie wraps, preferably black

Spare Parts Required



- Gripper Harness

To replace the Gripper Harness, perform the following procedure:

Step	Action
1.	Turn off the robot power and remove the AC power cord.
2.	Remove the Theta Cover.
3.	Unplug the gripper harness from the gripper controller.
4.	Remove the gripper harness clamp plate from the theta frame.
5.	Un-coil the gripper harness from around the theta housing.
6.	Remove the gripper harness clamp plate from the theta housing.
7.	Clip the tie wraps holding the gripper harness connectors and gripper motor cables to the gripper motor, and unplug the old gripper harness from the gripper motor.
8.	Replace the old gripper harness with the new one and replace tie wraps to clamp gripper harness to gripper motor inside theta housing.
9.	Replace the gripper harness clamp plate on the theta housing.

Step	Action
10.	Rotate theta clockwise when looking down from top of the theta until it hits hard stop.
11.	Coil gripper harness five turns around theta housing when theta is against hard stop.
12.	Clamp free end of harness with harness clamp plate on theta frame.
13.	Fold harness and thread up behind theta frame to gripper controller and plug back into gripper controller. 

Replacing the Gripper

 DANGER Electrical Shock	
<p>Working with energized equipment may cause electrical shock and may result in serious injury or death.</p> <ul style="list-style-type: none">Remove the AC power before replacing the Gripper.	

Tools Required:

- 2.5 mm hex driver or hex L wrench
- 2.0 mm hex driver or hex L wrench

Spare Parts Required

- Theta/Gripper assembly

The gripper is tightly integrated into the theta housing to conserve space. Therefore replacing the gripper only is not a recommended field service procedure. If the gripper motor fails for any reason, the entire gripper theta assembly should be replaced.

To replace the gripper, perform the following procedure:

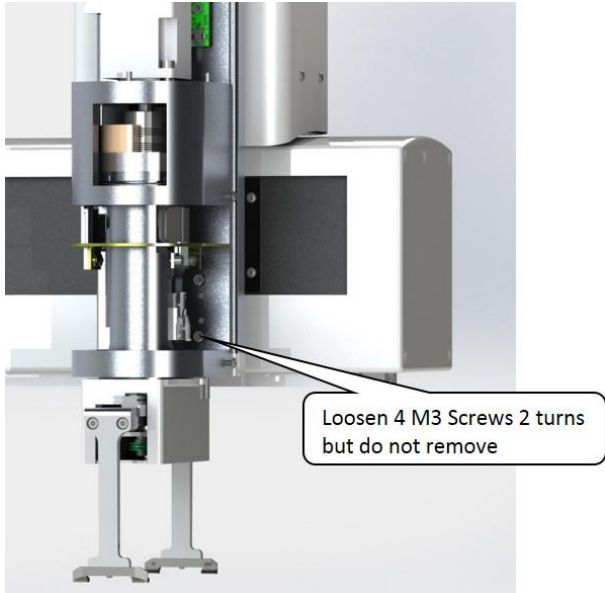
Step	Action
1.	Turn off the robot power and remove the AC power cord.
2.	Remove the Theta axis cover.
3.	Unplug the harness from the theta motor, encoder interface board and gripper controller.
4.	Disconnect the Echain from the theta/gripper mount plate by removing the (2) M3 X 6 mm FHCS.
5.	Remove the entire Theta/Gripper assembly by loosening the (4) M3 X 10 mm SHCS 2 turns and sliding the assembly up and out of the T slots in the Z-axis extrusion.
6.	Install a new assembly and re-assemble.
7.	Recalibrate the robot. 

Installing the Optional GIO Board

Brooks sells a digital IO board that provides 12 inputs and 8 outputs as an option; email sales.preciseflex@brooksautomation.com. This board may be installed on the rear cover of the X-axis if desired.

This board is provided with a 150mm pigtail harness to a 25-pin Dsub connector. The board is attached with (4) M3 X 10 mm SHCS and the 25-pin Dsub is attached with standard D-sub 4-40 mounting standoffs. This board is typically installed at the factory, but can be installed by a user per below.

Tools Required:

- 2.0 mm hex driver or hex L wrench
- 2.5 mm hex driver
- M5 socket driver
- M5 open end wrench

Spare Parts Required:

- GIO Digital IO Board see "Spare Parts List"

To install the GIO Board, follow this procedure:

Step	Action
1.	Remove the rear cover from the X-axis.
2.	Attach the GIO board to the PEM standoffs on the left end of the 10-pin IDC connector towards the controller as shown below.
3.	Plug in the 26-pin IDC connector on GIO to 25-pin Dsub pigtail harness into the GIO board and attach the 25-pin Dsub connector to the rear cover cutout after removing the blanking panel from the cutout.
4.	Fold the 25-pin ribbon cable pigtail into a loop fold between the GIO board and the 25-pin Dsub connector.
5.	Plug the RS485 10 conductor ribbon cable pigtail into the GIO board on the electronics plate.
6.	Remove J7, J8, J9, and J10 address jumpers on the GIO board J7-J10, see picture below.
7.	Set value 8 in Data ID 151 to the correct value "GIO_8". This parameter may be found in Setup/Parameter Database/Controller/System ID.
8.	For example, for an XZT, with servo gripper robot this ID should read "<Controller Serial No>", "GSB_1", "GSB_2", "GSB_3", ",", ",", ",", "GIO_8". For other robot configurations, the content of values 2-7 may vary.

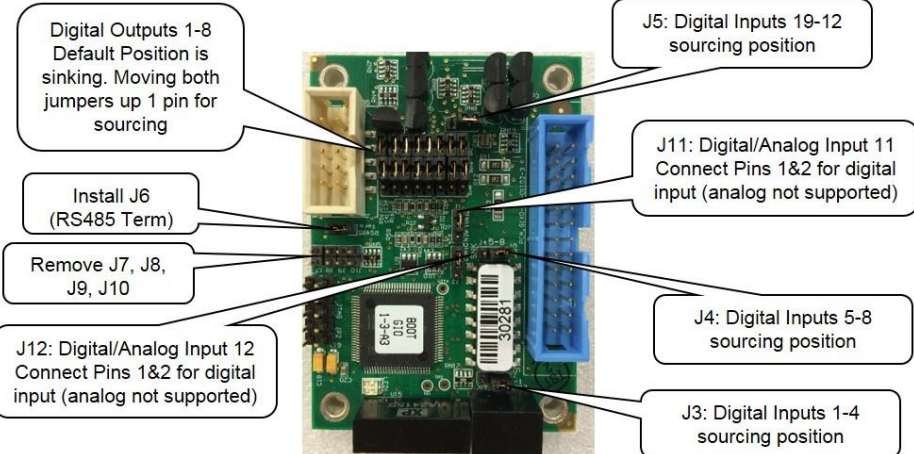
Step	Action
9.	When adding the GIO at the controller end of the RS485 daisy chain, remove the J6 RS485 termination jumper from the top board of the controller, located next to the RS485 10 pin ribbon cable connector in the controller.
10.	GIO signals may then be checked under Control Panels/Remote IO/Network Node 8. Software addresses are described in the RS485 Remote IO Module (GIO) section. Set other jumpers as desired for sourcing and sinking, see below.
11.	<p>Attach rear panel.</p> <p>For this GIO, it is configured as "GIO8" so the 8 outputs will be addressed as 800013-800020 and the 12 inputs will be addressed as 810001-810012. See jumpers below. Inputs and outputs are 24 VDC with outputs limited to 100mA. For pin assignments on the 25 pin Dsub, see "RS485 Remote IO Module (GIO)".</p> 

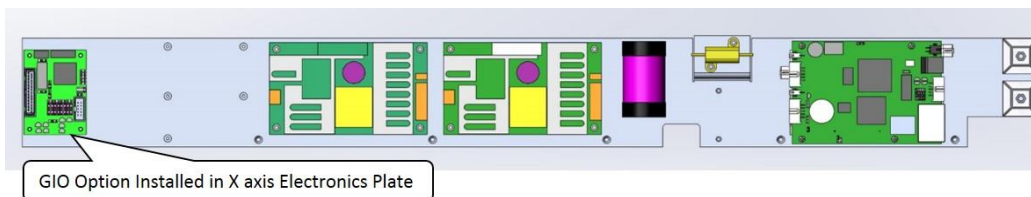

Figure 6-5: GIO Option Installed

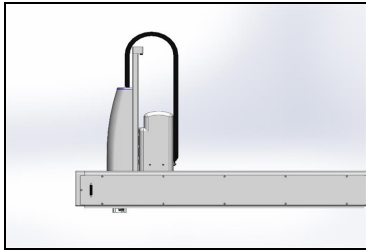

Figure 6-6: GIO Board Installed

Appendices

Appendix A: Product Specifications

General Specification	Range
Range of Motion & Resolution	
J1 (X) Axis	635 mm or 1270 mm for XZ version, 500 mm
J3 (Z) Axis	229 mm with XZ version
J4 (Theta) Axis	+/- 270 degrees
Gripper Travel	76 to 136 mm
Spring Gripper Force	2-23 Newtons closing, 2-10 Newtons opening, 7 Newtons power off
Resolution	10 microns typical
Repeatability	+/- 0.100 mm overall in X and Z directions at 18-22C
Performance and Payload	
Maximum acceleration	10,000 mm/sec ² with 1000gm payload
Maximum speed	1,500 mm/sec with 1000gm payload for XZ
Controller	<i>AVAILABLE GUIDANCE CONTROLLERS:</i> Guidance 1400D, Guidance 1100T Slave Amp, GIO optional IO Board
Interfaces	
General Communications	RS-232 channel, 100 Mb Ethernet
Digital I/O Channels	Four optically isolated 5-24 V inputs, four optically isolated 24 V outputs at 100ma available on facilities panel at end cap. Additional 12 isolated inputs and 8 isolated outputs available as option at back panel. Remote I/O is also available.
Pneumatic Lines	One air line, 75 PSI maximum, provided at outer link and routed internally to fittings on the Facilities Panel if Pneumatic Option selected.
Operator Interface	Web based operator interface supports local or remote control via browser connected to embedded web server.

General Specification	Range
Programming Interface	Three methods available: DIO MotionBlocks (PLC), embedded Guidance Programming Language (standalone), PC controlled over Ethernet using TCP/IP.
Required Power	The robot's power supplies have an input range of 100 to 240 VAC, +/- 10%, 50/60 Hz. 200 Watts typical 400 watts maximum
Weight, XZTG version	22 kg for 635 mm travel version, 32 kg for 1270 mm version

Appendix B: Environmental Specifications

The PreciseFlex™ Robots must be installed in a clean, non-condensing environment with the following specifications:

General Specification	Range & Features
Ambient temperature	4° C to 40° C
Indoor use only	
Storage and shipment temperature	-25° C to +55° C
Humidity range	10 to 55%, non-condensing, non-corrosive
Altitude	Up to 3000 m
Voltage	100-240 VAC +/- 10%, 50/60 Hz
Mains cord rating, min	18AWG, 3 conductor, 5 Amps min
Pollution Degree	2
Approved Cleaning Agents	IPA, 70% Ethanol/30% water, H2O2 Vapor up to 1000 ppm
IP rating	11
IK impact rating	IK08: 5 Joule

Appendix C: Spare Parts List

NOTE: Email support_preciseflex@brooksautomation.com for help replacing spare parts.

Description	Part Number
Absolute Encoder Battery Assembly, D cell	PF00-EA-00002
X-axis Motor Assembly	PP00-MA-00053
Z Motor Assembly	PP00-MA-00051
Theta Motor Assembly	PF03-MA-00001-E3
Gripper Motor Assembly	PF04-MA-00004-E2
X-axis 12 mm belt 635 mm X travel, for XZ robot	PP00-MC-X0006 1588 mm length
X-axis 12 mm belt 1270 mm X travel, for XZ robot	PP00-MC-X0006 2855 mm length
Z-axis motor belt	PP00-MC-X0028
Z-axis output belt, 229 mm travel	PP00-MC-X0029
Z-axis output belt, 260 mm travel	PP00-MC-X0029
Gripper Spring and Cable Assembly	PP00-MA-00055
G1400D Controller	G1XF-EA-A1400
G1100T Slave Controller SE ("GSB3")	G1X0-EA-T1101
G1100T Slave Controller Diff ("GSB3")	G1X0-EA-T1101-4D
GIO Digital IO Board with pigtails	GIO1-EA-01104
24VDC Supply	PS10-EP-00125
48VDC Motor Supply	PS10-EP-48365
Estop Box	PP10-EA-00022
Pendant	PP10-EA-00013
Harness, Gripper	PP0H-MA-00001
Encoder Wiring PCA	PP1C-EA-00001

Appendix D: Preventive Maintenance

Frequency	Description
Every year	Check belt tension all belts, re-tension if necessary
Every year	Check all joints in “free mode” for low bearing friction
Every three years	Replace all timing belts for high duty cycle applications

Appendix E: Belt Tensions, Gates Tension Meter

In some cases it may be desirable to confirm the belt tension of one of the axes in the robot. However in the case of the long belts it is possible that after a period of operation, the belt may stretch enough that the tension spring pre-load screw may need to be adjusted. The tension can be checked with a Gates Sonic Tension Meter, Model 507 C (Figure 7-1).



Figure 7-1: Gates Sonic Tension Meter, Model 507 C

To use the tension meter, follow this procedure:

Step	Action
1.	Turn on the power.
2.	Click the Mass button.
3.	Enter the belt mass from the table below.

Step	Action
4.	Click the Width button.
5.	Enter the belt width from the table below.
6.	Click the Span button.
7.	Enter the belt free span from the table below.
8.	Make sure the actual span of the belt in the robot is set to the value entered for "Span." For longer belts, move the carriage of the robot so the span does not exceed 500 mm, or the belt frequency will be so low, it will be difficult to get a reading on the tension meter.
9.	Click Select to record the data.
10.	Click Measure to take a tension reading.
11.	Place the microphone near the belt, typically within 3 mm or so.
12.	Gently pluck the belt so that it vibrates. The tension meter will calculate the belt tension from the acoustic vibrations and display the tension in Newtons.
13.	Compare the tension to Table 7-1 below. Adjust the belt tension preload screws if necessary.

Table 7-1: Belt Tensioning

Axis	Mass (g)	Width (mm)	Span (mm)	Tension (N)
X Short	2.8	20		90-100
X Long	2.8	20	1440	90-100
Y - Axis	2.8	12	485	90-100
Z Stage 1	2.8	9	85	50-60
Z Stage 2 Short	2.8	20	255	90-100

Appendix F: Facilities Panel

The Facilities Panel on the left end cap includes:

- System AC input power receptacle
- Lighted AC on/off power switch
- Connectors for controller input and output signals

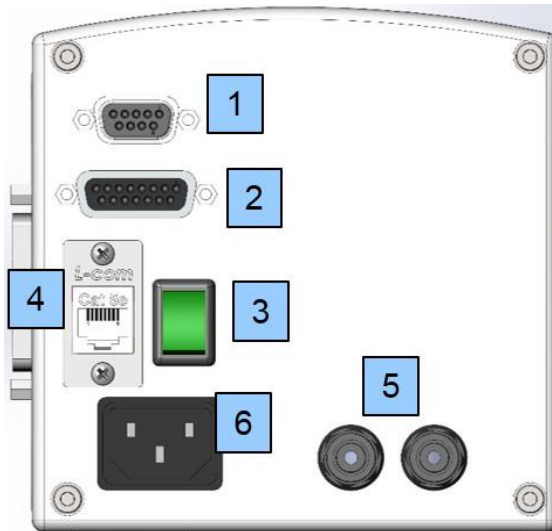

Item	Name	Description
1	9 Pin Dsub	Pendant and EStop
2	15 Pin Dsub	Digital IO
3	Switch	Power On with Light
4	RJ45	Ethernet Connector
5	Air	.125in air hose in
6	Power	Power Input with Filter